

Orientalmotor

Rotary Encoder Dust and Water Resistant IP65 Type

The IP65 type has been added to the lineup of magnetic incremental encoder. Resolution 100 P/R to 4000 P/R Maximum.

Degree of Protection

“IP65”

Ideal for Environments With Water and Dust!



Issue

In environments affected by water droplets or dust, the rotary encoder must be protected with a cover.

Solution

It prevents the infiltration of dust and water droplets from the outside, and can be mounted without a cover.

Compact and Lightweight

Integrated Cable

Degree of Protection “IP65”

35 mm

6 mm

40 mm

Mass 110 g

Cable Length: 1 m

Recommended Applications



Food and Packaging Machinery, Transportation Equipment, Machine Tools, Semiconductor Manufacturing Equipment, etc.

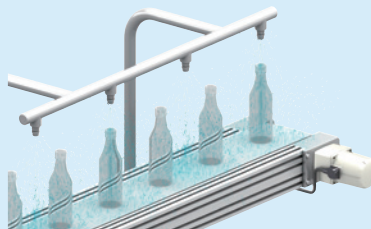

Conveyor

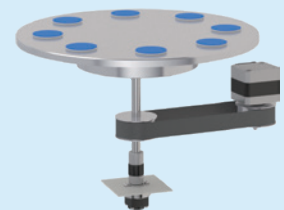

Index Table

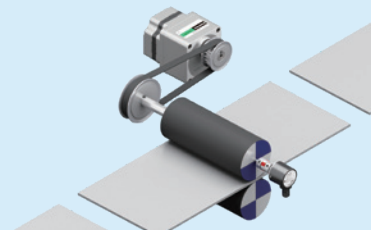



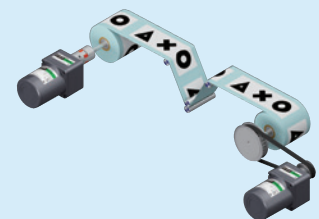

Roll Feed



Winding

Product Line

Installation Size [mm]	Degree of Protection	Shaft Shape	Output Circuit Type		
			Voltage Output (Power supply voltage 5 VDC)	Line Driver Output (Power supply voltage 5 VDC)	Open-collector Output (Power supply voltage 5 to 24 V DC)
Ø 30	IP20	Round Shaft 	●	●	●
		Hollow Shaft 	●	●	●
Ø 40	IP20	Round Shaft 	●	●	●
		Hollow Shaft 	●	●	●
	IP65	Round Shaft 	—	NEW	NEW

Helps With Predictive Maintenance of Machinery

The Actual Position, Speed, and Rotation Direction of the Mechanism Can Be Detected

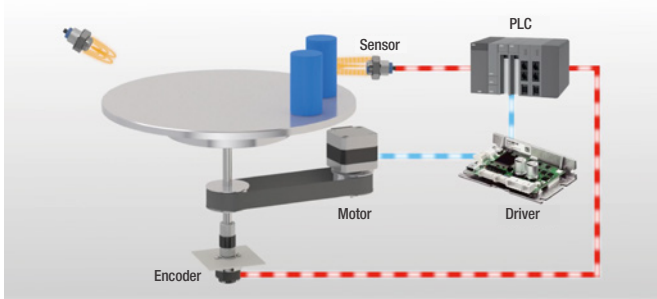

Comparing controller output pulses with encoder feedback allows rapid detection of stoppages due to foreign objects or other faults.

Easy Mounting

Easy Alignment of Mechanical Home and Z-phase Signal

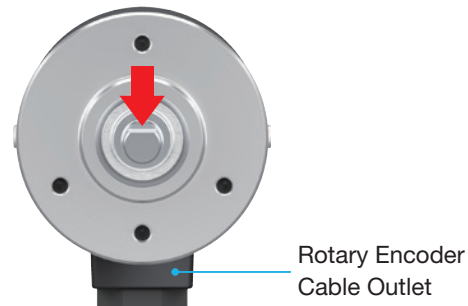

When the cable outlet is facing down and the shaft flat section is in the position indicated by the arrow, Z-phase signal is output once per revolution.

Dimensions and Mounting Pitch

Highly Versatile Mounting Dimensions.

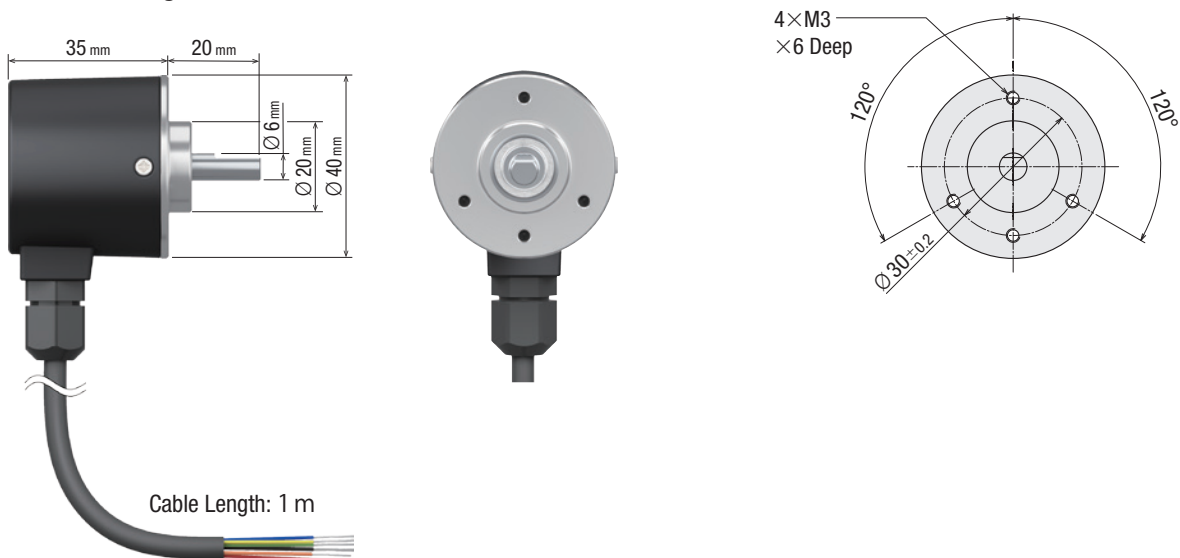

Orientalmotor

Specifications are subject to change without notice. This catalogue was published in October 2025.

www.orientalmotor.eu

EN	UK	DE
IT	ES	

Customer Service Center (German & English)
Free Hotline 00800-22 55 66 22 - tech-support@orientalmotor.de

These products are manufactured at plants certified with the international standards ISO 9001 (for quality assurance) and ISO 14001 (for systems of environmental management).