

2-Phase Stepping Motors High-Torque PKP Series

● Connection Information
 Technical reference → Page G-1
 Safety standards → Page H-2

High-torque **PKP** Series offers a standard type with a resolution of 200 steps per revolution (1.8°/step) and a geared type (high torque, higher resolution). The dedicated driver is required separately to operate the motor.

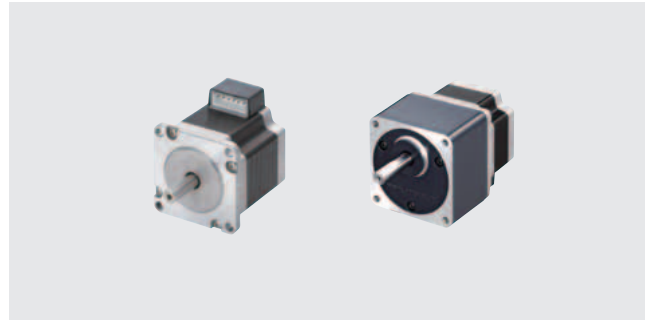

Features

● High-Torque Design

PKP Series generating high torque of approximately 1.2 to 1.7 times (maximum holding torque) the **PK** Series standard type of same size.

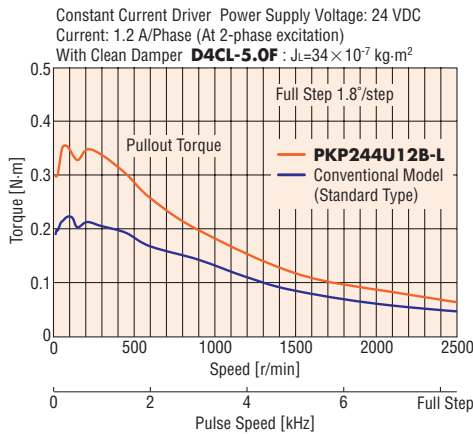

The Advantages of Using a High Torque Motor

● Lower Power Consumption and Lower Heat Generation

If the running current of a **PKP** Series motor is decreased and the motor is operated at the same torque as the **PK** Series standard type, current consumption and temperature rise can be reduced.

Power consumption can be reduced

Comparison of driver power consumption when low-speed torque is tailored to the **PK** Series standard type

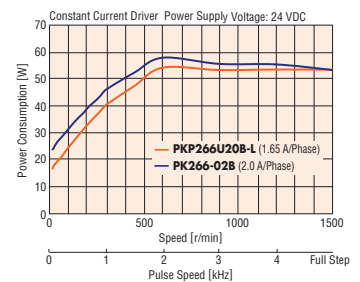

Characteristics of Decreased Running Current in **PKP** Series Motors

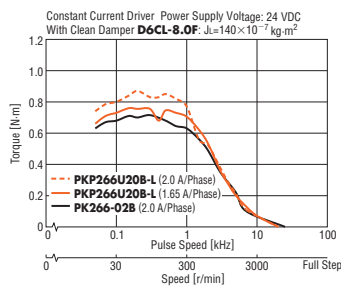

Power consumption reduced by **20%** (at low speed)

Temperature rise can be reduced

Comparison of motor surface temperature rise when low-speed torque is tailored to the **PK** Series standard type

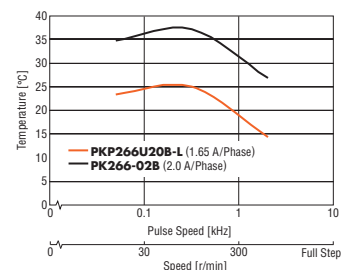

Temperature increases of **10°C** and more are suppressed

Downsizing of Your Motor

By using a **PKP** Series motor, which has the same torque as the **PK** Series standard type, the motor can be downsized.

Comparison of Speed-Torque Characteristics between **PKP244U12A-L** and **PK264-02A**

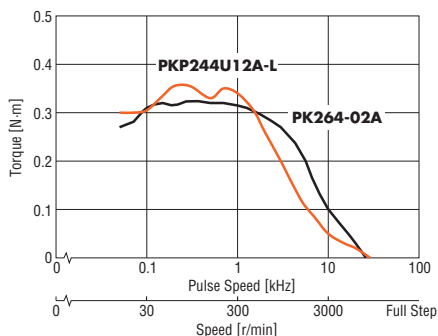

The motor can be downsized, even if the torque is the same!

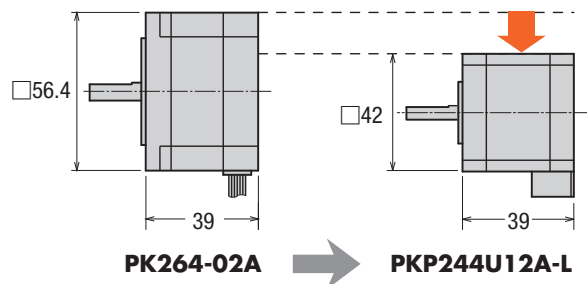

SH Geared Type

This geared type is effective for reducing speed, increasing torque, higher resolution and low vibration. The **PK** Series has a broader permissible speed range than the **SH** geared type, and is also easier to use.

PK Series PK243A1-SG10

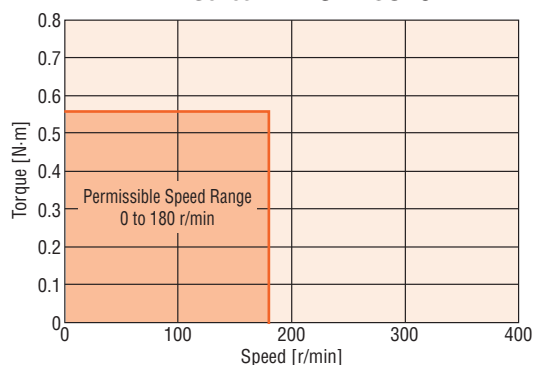

PKP Series PKP243U09A-SG10

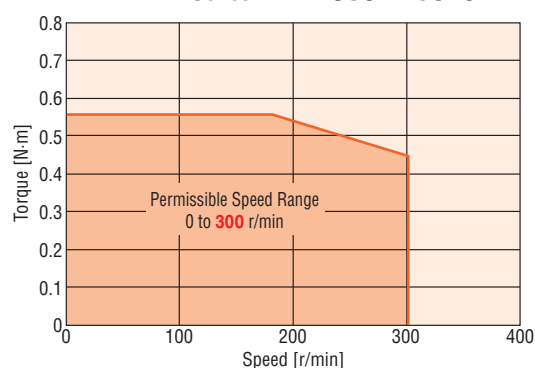

Motor Lineup

Bipolar and unipolar models are available for all types.

	Motor Frame Size				
	20 mm	28 mm	35 mm	42 mm	56.4/60 mm
Standard Type					
SH Geared Type					

System Configuration

These accessories enable 2-phase **PKP** Series products to be used for various operations.

*1 Not supplied

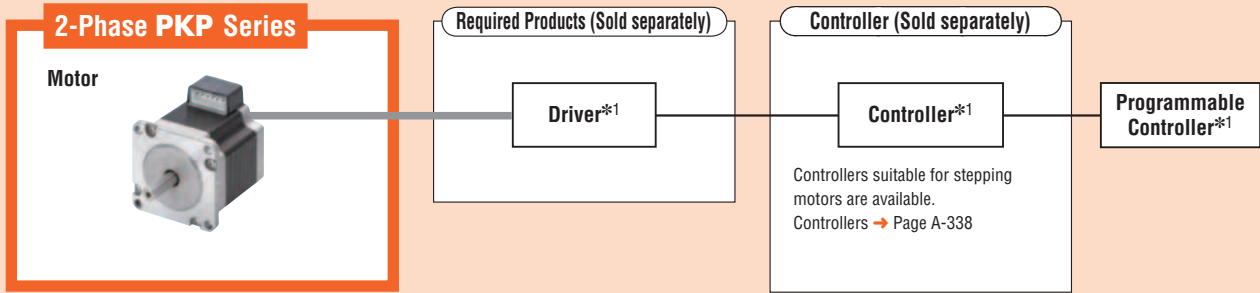

Accessories (Sold separately)



① **Motor Mounting Brackets**
(→ Page A-369)



② **Flexible Couplings**
(→ Page A-359)



③ **Clean Dampers**
(→ Page A-375)



④ **Connection Cables*2**
(→ Page A-358)

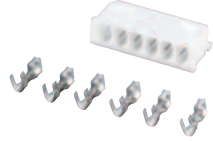

⑤ **Motor Connector Sets**
(→ Page A-358)

*2 A connection cable (0.6 m) is included with products that have product names ending in "L."

Number	Name	Overview
①	Motor Mounting Brackets	Dedicated mounting bracket for the motor.
②	Flexible Couplings	Coupling that connects the motor shaft to the driven shaft.
③	Clean Dampers	Dedicated damper for suppressing stepping motor vibration.
④	Connection Cables	Lead wire with a connector crimped for connector-coupled motors (0.6 m, 1 m).
⑤	Motor Connector Sets	Set of connector housings and contacts for use with connector-coupled motors (30 units).

System Configuration Example

2-Phase PKP Series PKP264D28B-L	+	Sold Separately		
		Motors Mounting Bracket PAL2P-2	Flexible Coupling MCS200808	Clean Damper D6CL-8.0F

● The system configuration shown above is an example. Other combinations are available.

Product Number Code

Standard Type

PKP 2 6 4 D 28 A - L

① ② ③ ④ ⑤ ⑥ ⑦ ⑧

①	Series Name	PKP: PKP Series
②	2-Phase	
③	Motor Frame Size	1: 20 mm 2: 28 mm 3: 35 mm 4: 42 mm 6: 56.4 mm
④	Motor Case Length	
⑤	Number of Lead Wires	D: 4 U: 5 or 6
⑥	Winding Specifications	
⑦	Motor Shaft Type	A: Single Shaft B: Double Shaft
⑧	Connection Cable	L: Included (0.6 m)

SH Geared Type

PKP 2 4 3 U 09 B - SG 18 - L

① ② ③ ④ ⑤ ⑥ ⑦ ⑧ ⑨ ⑩

①	Series Name	PKP: PKP Series
②	2-Phase	
③	Motor Frame Size	2: 28 mm 4: 42 mm 6: 60 mm
④	Motor Case Length	
⑤	Number of Lead Wires	D: 4 U: 6
⑥	Winding Specifications	
⑦	Motor Shaft Type	A: Single Shaft B: Double Shaft
⑧	Gearhead Type	SG: SH Geared Type
⑨	Gear Ratio	
⑩	Connection Cable	L: Included (0.6 m)

Product Line

● Standard Type (4 lead wires)

Product Name (Single shaft)	Product Name (Double shaft)
PKP213D05A	PKP213D05B
PKP214D06A	PKP214D06B
PKP223D15A-L	PKP223D15B-L
PKP224D15A-L	PKP224D15B-L
PKP225D15A-L	PKP225D15B-L
PKP233D15A-L	PKP233D15B-L
PKP235D15A-L	PKP235D15B-L
PKP243D15A-L	PKP243D15B-L
PKP244D15A-L	PKP244D15B-L
PKP245D15A-L	PKP245D15B-L
PKP246D15A-L	PKP246D15B-L
PKP264D28A-L	PKP264D28B-L
PKP266D28A-L	PKP266D28B-L
PKP268D28A-L	PKP268D28B-L

● Standard Type (5 or 6 lead wires)

Product Name (Single shaft)	Product Name (Double shaft)
PKP213U05A	PKP213U05B
PKP214U06A	PKP214U06B
PKP223U09A-L	PKP223U09B-L
PKP224U09A-L	PKP224U09B-L
PKP225U09A-L	PKP225U09B-L
PKP233U12A-L	PKP233U12B-L
PKP235U12A-L	PKP235U12B-L
PKP243U04A-L	PKP243U04B-L
PKP243U06B-L	PKP243U06B-L
PKP243U09A-L	PKP243U09B-L
PKP244U04A-L	PKP244U04B-L
PKP244U08A-L	PKP244U08B-L
PKP244U12A-L	PKP244U12B-L
PKP245U05A-L	PKP245U05B-L
PKP245U08A-L	PKP245U08B-L
PKP245U12A-L	PKP245U12B-L
PKP246U12A-L	PKP246U12B-L
PKP264U10A-L	PKP264U10B-L
PKP264U20A-L	PKP264U20B-L
PKP264U30A-L	PKP264U30B-L
PKP266U10A-L	PKP266U10B-L
PKP266U20A-L	PKP266U20B-L
PKP266U30A-L	PKP266U30B-L
PKP268U10A-L	PKP268U10B-L
PKP268U20A-L	PKP268U20B-L
PKP268U30A-L	PKP268U30B-L

● SH Geared Type (4 lead wires)

Product Name (Single shaft)	Product Name (Double shaft)
PKP223D15A-SG7.2-L	PKP223D15B-SG7.2-L
PKP223D15A-SG9-L	PKP223D15B-SG9-L
PKP223D15A-SG10-L	PKP223D15B-SG10-L
PKP223D15A-SG18-L	PKP223D15B-SG18-L
PKP223D15A-SG36-L	PKP223D15B-SG36-L
PKP243D15A-SG3.6-L	PKP243D15B-SG3.6-L
PKP243D15A-SG7.2-L	PKP243D15B-SG7.2-L
PKP243D15A-SG9-L	PKP243D15B-SG9-L
PKP243D15A-SG10-L	PKP243D15B-SG10-L
PKP243D15A-SG18-L	PKP243D15B-SG18-L
PKP243D15A-SG36-L	PKP243D15B-SG36-L
PKP264D14A-SG3.6-L	PKP264D14B-SG3.6-L
PKP264D28A-SG3.6-L	PKP264D28B-SG3.6-L
PKP264D14A-SG7.2-L	PKP264D14B-SG7.2-L
PKP264D28A-SG7.2-L	PKP264D28B-SG7.2-L
PKP264D14A-SG9-L	PKP264D14B-SG9-L
PKP264D28A-SG9-L	PKP264D28B-SG9-L
PKP264D14A-SG10-L	PKP264D14B-SG10-L
PKP264D28A-SG10-L	PKP264D28B-SG10-L
PKP264D14A-SG18-L	PKP264D14B-SG18-L
PKP264D28A-SG18-L	PKP264D28B-SG18-L
PKP264D14A-SG36-L	PKP264D14B-SG36-L
PKP264D28A-SG36-L	PKP264D28B-SG36-L

● SH Geared Type (6 lead wires)

Product Name (Single shaft)	Product Name (Double shaft)
PKP223U09A-SG7.2-L	PKP223U09B-SG7.2-L
PKP223U09A-SG9-L	PKP223U09B-SG9-L
PKP223U09A-SG10-L	PKP223U09B-SG10-L
PKP223U09A-SG18-L	PKP223U09B-SG18-L
PKP223U09A-SG36-L	PKP223U09B-SG36-L
PKP243U09A-SG3.6-L	PKP243U09B-SG3.6-L
PKP243U09A-SG7.2-L	PKP243U09B-SG7.2-L
PKP243U09A-SG9-L	PKP243U09B-SG9-L
PKP243U09A-SG10-L	PKP243U09B-SG10-L
PKP243U09A-SG18-L	PKP243U09B-SG18-L
PKP243U09A-SG36-L	PKP243U09B-SG36-L
PKP264U10A-SG3.6-L	PKP264U10B-SG3.6-L
PKP264U20A-SG3.6-L	PKP264U20B-SG3.6-L
PKP264U10A-SG7.2-L	PKP264U10B-SG7.2-L
PKP264U20A-SG7.2-L	PKP264U20B-SG7.2-L
PKP264U10A-SG9-L	PKP264U10B-SG9-L
PKP264U20A-SG9-L	PKP264U20B-SG9-L
PKP264U10A-SG10-L	PKP264U10B-SG10-L
PKP264U20A-SG10-L	PKP264U20B-SG10-L
PKP264U10A-SG18-L	PKP264U10B-SG18-L
PKP264U20A-SG18-L	PKP264U20B-SG18-L
PKP264U10A-SG36-L	PKP264U10B-SG36-L
PKP264U20A-SG36-L	PKP264U20B-SG36-L

The following items are included in each product.
 Motor, Connection Cable*, Operating Manual
 *Only products that have product names that end in "L"

Standard Type Frame Size 20 mm (4 lead wires)

Specifications RoHS

Product Name	Connection Type	Maximum Holding Torque	Rotor Inertia	Rated Current	Voltage	Resistance per Phase	Inductance	Basic Step Angle	Wirings and Connections
Single Shaft Double Shaft		N·m	J: kg·m ²	A/Phase	VDC	Ω/Phase	mH/Phase		(See Page A-276)
PKP213D05A PKP213D05B	Bipolar	0.02	1.6×10 ⁻⁷	0.5	4.25	8.5	4.1	1.8°	3
PKP214D06A PKP214D06B		0.036	2.9×10 ⁻⁷	0.6	3.9	6.5	3.5		

Speed – Torque Characteristics

PKP213D05A/PKP213D05B

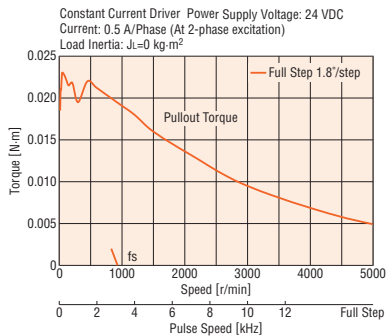

PKP214D06A/PKP214D06B

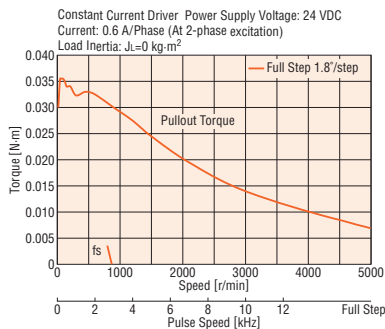

Note

● Depending on the driving conditions, a considerable amount of heat may be generated by the motor. Be sure to keep the motor case temperature at 100°C or less.

Dimensions (Unit = mm)

Product Name	L1	L2	Mass kg
PKP213D05A PKP213D05B	30	— 38	0.05
PKP214D06A PKP214D06B	40	— 48	0.07

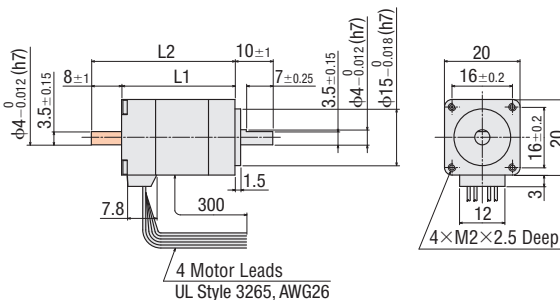

- These dimensions are for double shaft models.
For single shaft models, ignore the shaft in the shaded areas.
- The back shaft of the motor with double shaft type has the shaft flat in whole length.

Standard Type Frame Size 20 mm (5 lead wires)

Specifications RoHS

Product Name	Connection Type	Maximum Holding Torque	Rotor Inertia	Rated Current	Voltage	Resistance per Phase	Inductance	Basic Step Angle	Wirings and Connections
Single Shaft Double Shaft		N·m	J: kg·m ²	A/Phase	VDC	Ω/Phase	mH/Phase		(See Page A-276)
PKP213U05A PKP213U05B	Unipolar	0.014	1.6×10^{-7}	0.5	4.25	8.5	2.9	1.8°	2
PKP214U06A PKP214U06B		0.026	2.9×10^{-7}	0.6	4.2	7	2.4		

Speed – Torque Characteristics

PKP213U05A/PKP213U05B

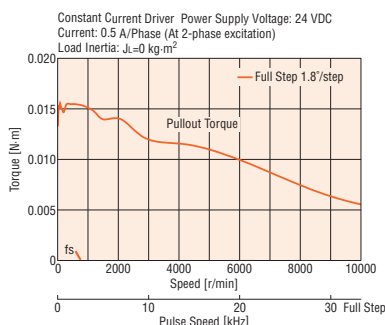

PKP214U06A/PKP214U06B

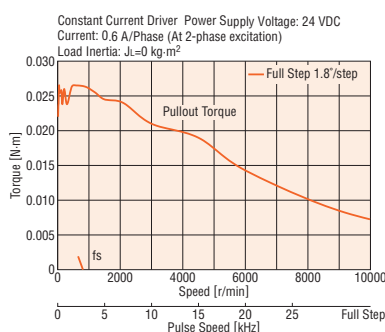

Note

- Depending on the driving conditions, a considerable amount of heat may be generated by the motor. Be sure to keep the motor case temperature at 100°C or less.

Dimensions (Unit = mm)

Product Name	L1	L2	Mass kg
PKP213U05A	30	—	0.05
PKP213U05B		38	
PKP214U06A	40	—	0.07
PKP214U06B		48	

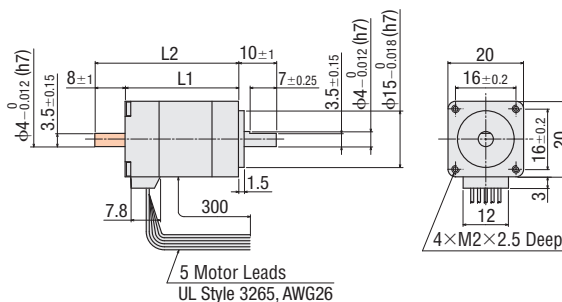

- These dimensions are for double shaft models. For single shaft models, ignore the shaft in the shaded areas.
- The back shaft of the motor with double shaft type has the shaft flat in whole length.

Standard Type Frame Size 28 mm (4 lead wires)

Specifications RoHS

Product Name	Connection Type	Maximum Holding Torque	Rotor Inertia	Rated Current	Voltage	Resistance per Phase	Inductance	Basic Step Angle	Wirings and Connections
Single Shaft Double Shaft		N·m	J: kg·m ²	A/Phase	VDC	Ω/Phase	mH/Phase		(See Page A-276)
PKP223D15A-L PKP223D15B-L	Bipolar	0.065	9×10 ⁻⁷	1.5	1.8	1.2	0.74	1.8°	3
PKP224D15A-L PKP224D15B-L		0.097	12×10 ⁻⁷		2.32	1.55	0.85		
PKP225D15A-L PKP225D15B-L		0.11	18×10 ⁻⁷		3	2.05	1		

● A connection cable (0.6 m) is included.

Speed – Torque Characteristics

PKP223D15A-L/PKP223D15B-L

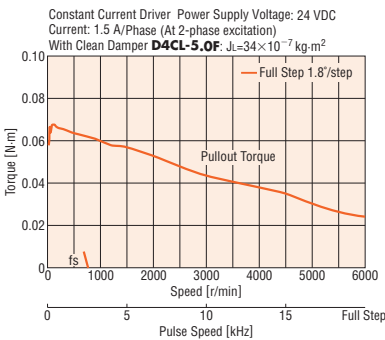

PKP224D15A-L/PKP224D15B-L

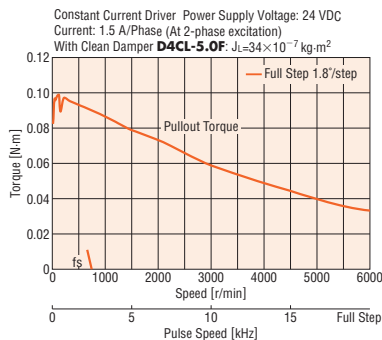

PKP225D15A-L/PKP225D15B-L

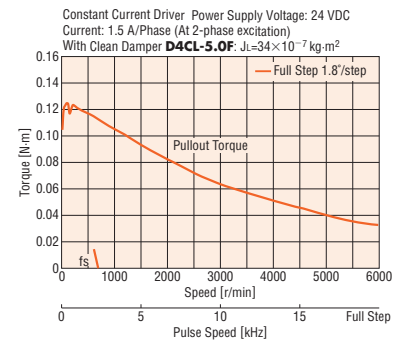

Note

● Depending on the driving conditions, a considerable amount of heat may be generated by the motor. Be sure to keep the motor case temperature at 100°C or less.

Dimensions (Unit = mm)

Product Name	Motor Product Name	L1	L2	Mass kg
PKP223D15A-L	PKP223D15A	32	—	0.11
PKP223D15B-L	PKP223D15B		42	
PKP224D15A-L	PKP224D15A	40	—	0.14
PKP224D15B-L	PKP224D15B		50	
PKP225D15A-L	PKP225D15A	51.5	—	0.2
PKP225D15B-L	PKP225D15B		61.5	

● Applicable Connector
Connector Housing: 51065-0600 (Molex)
Contact: 50212-8100 (Molex)
Crimp Tool: 57176-5000 (Molex)

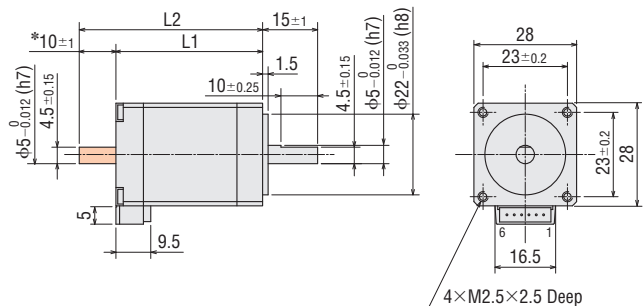

- * The length of the shaft flat on the double shaft model is 10±0.25.
- These dimensions are for double shaft models.
For single shaft models, ignore the shaft in the shaded areas.

● Included
Connection Cable
Product Name: **LC2B06A**

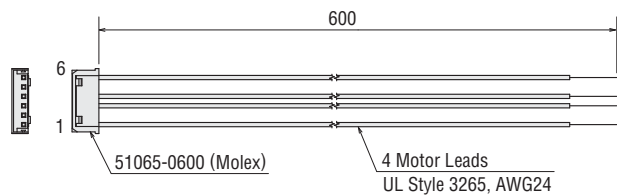

Accessories (Sold separately)

Connection cable and motor connector set are available as accessories.

- Connection cable → Page A-358
- Motor connector set → Page A-358

Standard Type Frame Size 28 mm (6 lead wires)

Specifications RoHS

Product Name	Connection Type	Maximum Holding Torque	Rotor Inertia	Rated Current	Voltage	Resistance per Phase	Inductance	Basic Step Angle	Wirings and Connections
Single Shaft Double Shaft		N·m	J: kg·m ²	A/Phase	VDC	Ω/Phase	mH/Phase		(See Page A-276)
PKP223U09A-L PKP223U09B-L	Unipolar	0.05	9×10 ⁻⁷	0.95	2.66	2.8	1	1.8°	1
PKP224U09A-L PKP224U09B-L		0.075	12×10 ⁻⁷		3.2	3.4	1.2		
PKP225U09A-L PKP225U09B-L		0.09	18×10 ⁻⁷		4.4	4.6	1.4		

● A connection cable (0.6 m) is included.

Speed – Torque Characteristics

PKP223U09A-L/PKP223U09B-L

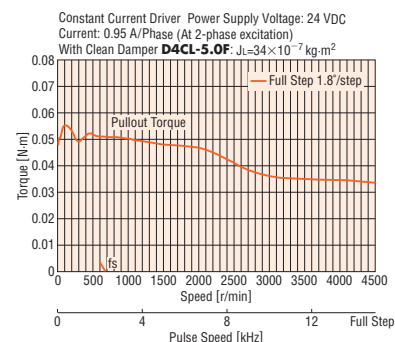

PKP224U09A-L/PKP224U09B-L

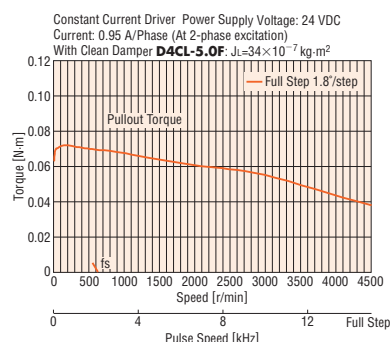

PKP225U09A-L/PKP225U09B-L

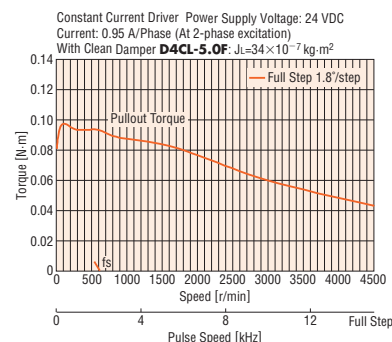

Note

● Depending on the driving conditions, a considerable amount of heat may be generated by the motor. Be sure to keep the motor case temperature at 100°C or less.

Dimensions (Unit = mm)

Product Name	Motor Product Name	L1	L2	Mass kg
PKP223U09A-L	PKP223U09A	32	—	0.11
PKP223U09B-L	PKP223U09B		42	
PKP224U09A-L	PKP224U09A	40	—	0.14
PKP224U09B-L	PKP224U09B		50	
PKP225U09A-L	PKP225U09A	51.5	—	0.2
PKP225U09B-L	PKP225U09B		61.5	

● Applicable Connector

Connector Housing: 51065-0600 (Molex)

Contact: 50212-8100 (Molex)

Crimp Tool: 57176-5000 (Molex)

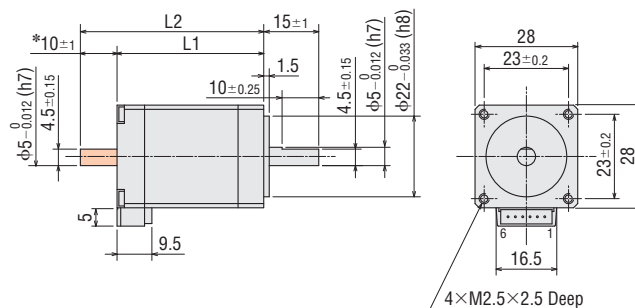

* The length of the shaft flat on the double shaft model is 10±0.25.

● These dimensions are for double shaft models.

For single shaft models, ignore the shaft in the shaded areas.

● Included

Connection Cable

Product Name: **LC2U06A**

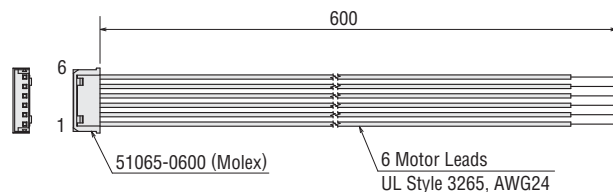

Accessories (Sold separately)

Connection cable and motor connector set are available as accessories.

● Connection cable → Page A-358

● Motor connector set → Page A-358

Standard Type Frame Size 35 mm (4 lead wires)

20 mm

28 mm

35 mm

42 mm

56.4 mm

60 mm

Specifications RoHS

Product Name	Connection Type	Maximum Holding Torque	Rotor Inertia	Rated Current	Voltage	Resistance per Phase	Inductance	Basic Step Angle	Wirings and Connections
Single Shaft Double Shaft		N·m	J: kg·m ²	A/Phase	VDC	Ω/Phase	mH/Phase		(See Page A-276)
PKP233D15A-L PKP233D15B-L	Bipolar	0.2	24×10 ⁻⁷	1.5	2.43	1.62	1.5	1.8°	3
PKP235D15A-L PKP235D15B-L		0.37	50×10 ⁻⁷		3.6	2.4	2.6		

● A connection cable (0.6 m) is included.

Speed – Torque Characteristics

PKP233D15A-L/PKP233D15B-L

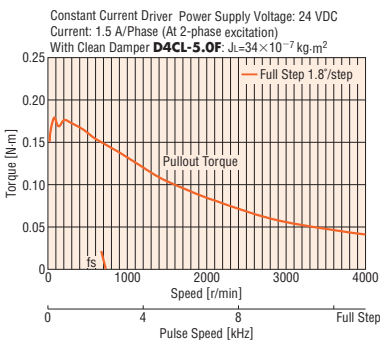

PKP235D15A-L/PKP235D15B-L

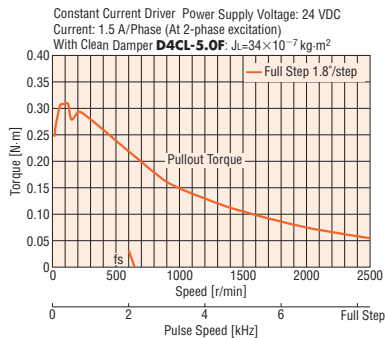

Note

● Depending on the driving conditions, a considerable amount of heat may be generated by the motor. Be sure to keep the motor case temperature at 100°C or less.

Dimensions (Unit = mm)

Product Name	Motor Product Name	L1	L2	Mass kg
PKP233D15A-L	PKP233D15A	37	—	0.18
PKP233D15B-L	PKP233D15B		52	
PKP235D15A-L	PKP235D15A	52	—	0.285
PKP235D15B-L	PKP235D15B		67	

● Applicable Connector
Connector Housing: 51103-0600 (Molex)
Contact: 50351-8100 (Molex)
Crimp Tool: 57295-5000 (Molex)

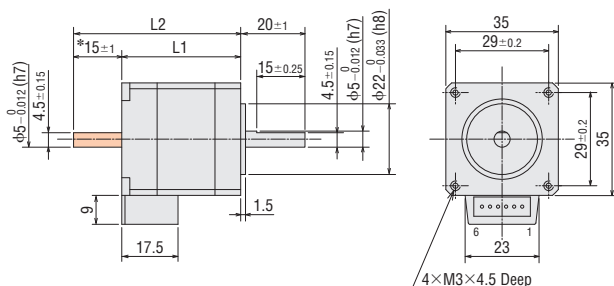

* The length of the shaft flat on the double shaft model is 15±0.25.

● These dimensions are for double shaft models.
For single shaft models, ignore the shaft in the shaded areas.

● Included
Connection Cable
Product Name: **LC2B06B**

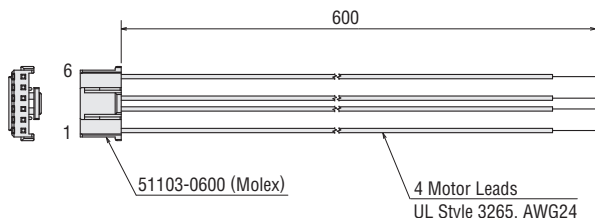

Accessories (Sold separately)

Connection cable and motor connector set are available as accessories.

- Connection cable → Page A-358
- Motor connector set → Page A-358

Standard Type Frame Size 35 mm (6 lead wires)

Specifications RoHS

Product Name	Connection Type	Maximum Holding Torque	Rotor Inertia	Rated Current	Voltage	Resistance per Phase	Inductance	Basic Step Angle	Wirings and Connections
Single Shaft Double Shaft		N·m	J: kg·m ²	A/Phase	VDC	Ω/Phase	mH/Phase		(See Page A-276)
PKP233U12A-L PKP233U12B-L	Unipolar	0.16	24×10 ⁻⁷	1.2	3.24	2.7	1.4	1.8°	1
PKP235U12A-L PKP235U12B-L		0.3	50×10 ⁻⁷		4.08	3.4	2		

● A connection cable (0.6 m) is included.

Speed – Torque Characteristics

PKP233U12A-L/PKP233U12B-L

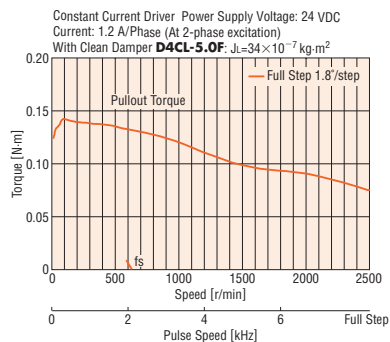

PKP235U12A-L/PKP235U12B-L

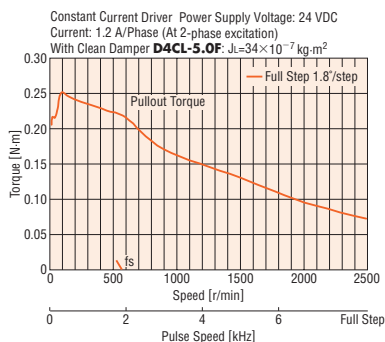

Note

● Depending on the driving conditions, a considerable amount of heat may be generated by the motor. Be sure to keep the motor case temperature at 100°C or less.

Dimensions (Unit = mm)

Product Name	Motor Product Name	L1	L2	Mass kg
PKP233U12A-L	PKP233U12A	37	—	0.18
PKP233U12B-L	PKP233U12B		52	
PKP235U12A-L	PKP235U12A	52	—	0.285
PKP235U12B-L	PKP235U12B		67	

● Applicable Connector
Connector Housing: 51103-0600 (Molex)
Contact: 50351-8100 (Molex)
Crimp Tool: 57295-5000 (Molex)

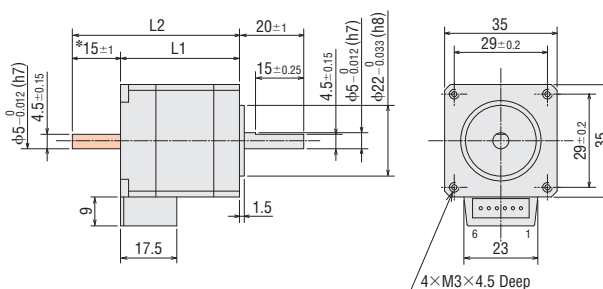

* The length of the shaft flat on the double shaft model is 15 ± 0.25 .

● These dimensions are for double shaft models.
For single shaft models, ignore the shaft in the shaded areas.

● Included
Connection Cable
Product Name: **LC2U06B**

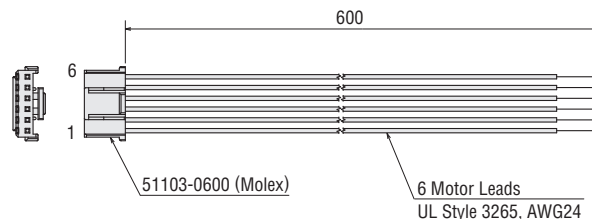

Accessories (Sold separately)

Connection cable and motor connector set are available as accessories.

- Connection cable → Page A-358
- Motor connector set → Page A-358

Standard Type Frame Size 42 mm (4 lead wires)

Specifications RoHS

Product Name	Connection Type	Maximum Holding Torque	Rotor Inertia	Rated Current	Voltage	Resistance per Phase	Inductance	Basic Step Angle	Wirings and Connections
Single Shaft Double Shaft		N·m	J: kg·m ²	A/Phase	VDC	Ω/Phase	mH/Phase		(See Page A-276)
PKP243D15A-L PKP243D15B-L	Bipolar	0.35	36×10 ⁻⁷	1.5	2.85	1.9	5	1.8°	3
PKP244D15A-L PKP244D15B-L		0.48	57×10 ⁻⁷		3.9	2.6	4.9		
PKP245D15A-L PKP245D15B-L		0.58	83×10 ⁻⁷		3.6	2.4	6.6		
PKP246D15A-L PKP246D15B-L		0.93	114×10 ⁻⁷		5.8	3.87	8		

● A connection cable (0.6 m) is included.

Speed – Torque Characteristics

PKP243D15A-L/PKP243D15B-L

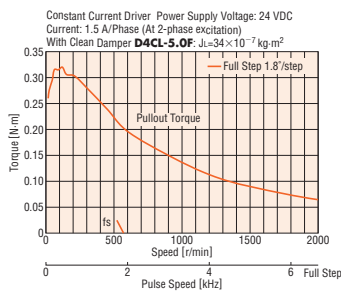

PKP244D15A-L/PKP244D15B-L

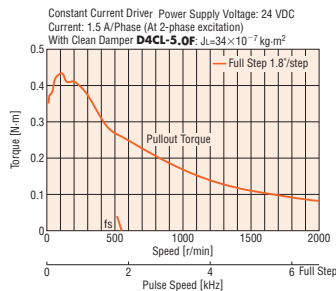

PKP245D15A-L/PKP245D15B-L

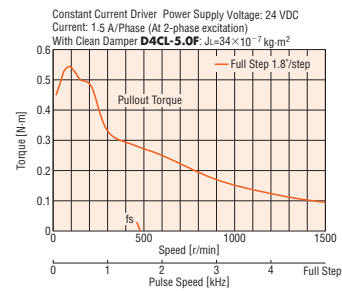

PKP246D15A-L/PKP246D15B-L

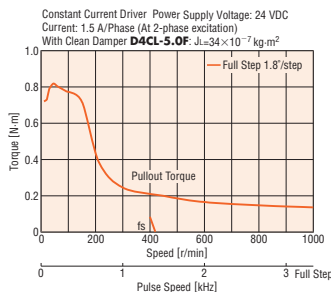

Note

● Depending on the driving conditions, a considerable amount of heat may be generated by the motor. Be sure to keep the motor case temperature at 100°C or less.

Dimensions (Unit = mm)

Product Name	Motor Product Name	L1	L2	Mass kg
PKP243D15A-L	PKP243D15A	33	—	0.25
PKP243D15B-L	PKP243D15B	—	48	—
PKP244D15A-L	PKP244D15A	39	—	0.3
PKP244D15B-L	PKP244D15B	—	54	—
PKP245D15A-L	PKP245D15A	47	—	0.39
PKP245D15B-L	PKP245D15B	—	62	—
PKP246D15A-L	PKP246D15A	59	—	0.5
PKP246D15B-L	PKP246D15B	—	74	—

● Applicable Connector

Connector Housing: 51103-0600 (Molex)
Contact: 50351-8100 (Molex)
Crimp Tool: 57295-5000 (Molex)

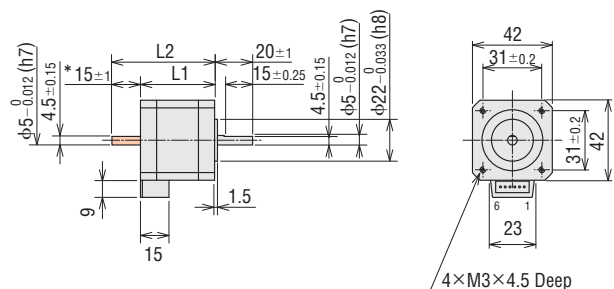

* The length of the shaft flat on the double shaft model is 15±0.25.
● These dimensions are for double shaft models.
For single shaft models, ignore the shaft in the shaded areas.

● Included

Connection Cable
Product Name: **LC2B06B**

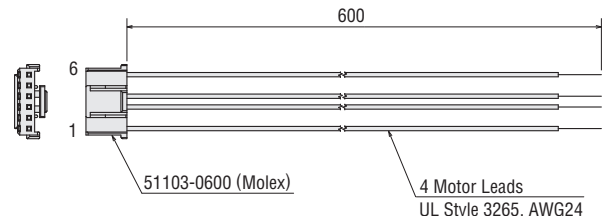

Accessories (Sold separately)

Connection cable and motor connector set are available as accessories.

- Connection cable → Page A-358
- Motor connector set → Page A-358

Standard Type Frame Size 42 mm (6 lead wires)

Specifications RoHS

Product Name	Connection Type	Maximum Holding Torque	Rotor Inertia	Rated Current	Voltage	Resistance per Phase	Inductance	Basic Step Angle	Wirings and Connections
Single Shaft Double Shaft		N·m	J: kg·m ²	A/Phase	VDC	Ω/Phase	mH/Phase		(See Page A-276)
PKP243U04A-L PKP243U04B-L	Unipolar	0.25	36×10 ⁻⁷	0.4	12	30	3.3	1.8°	1
PKP243U06A-L PKP243U06B-L				0.6	6.6	11	12.4		
PKP243U09A-L PKP243U09B-L				0.95	4.47	4.7	5		
PKP244U04A-L PKP244U04B-L		0.36	57×10 ⁻⁷	0.4	12	30	28.6		
PKP244U08A-L PKP244U08B-L				0.8	5.76	7.2	7.6		
PKP244U12A-L PKP244U12B-L				1.2	4.8	4	3.9		
PKP245U05A-L PKP245U05B-L		0.45	83×10 ⁻⁷	0.5	12	24	33		
PKP245U08A-L PKP245U08B-L				0.8	6.4	8	11.3		
PKP245U12A-L PKP245U12B-L				1.2	4.56	3.8	5		
PKP246U12A-L PKP246U12B-L		0.75	114×10 ⁻⁷	1.2	7.2	6	6.5		

● A connection cable (0.6 m) is included.

Speed – Torque Characteristics

PKP243U04A-L/PKP243U04B-L

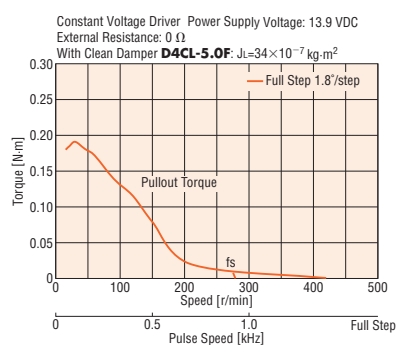

PKP243U06A-L/PKP243U06B-L

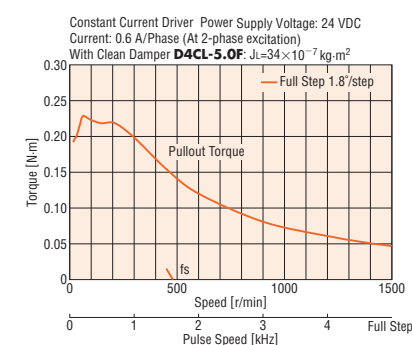

PKP243U09A-L/PKP243U09B-L

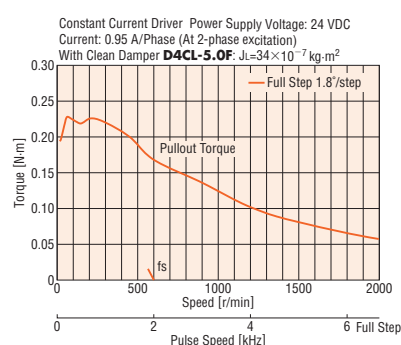

PKP244U04A-L/PKP244U04B-L

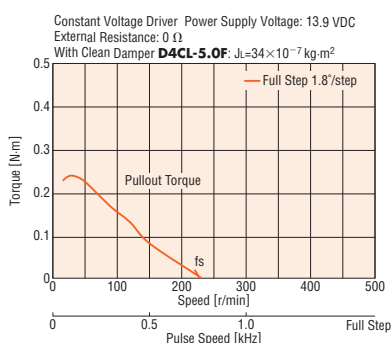

PKP244U08A-L/PKP244U08B-L

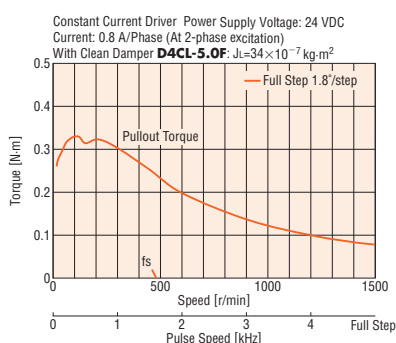

PKP244U12A-L/PKP244U12B-L

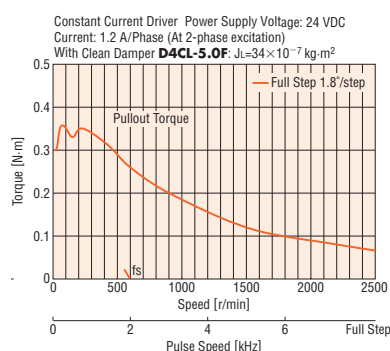

Note

● Depending on the driving conditions, a considerable amount of heat may be generated by the motor. Be sure to keep the motor case temperature at 100°C or less.

20 mm

28 mm

35 mm

PKP245U05A-L/PKP245U05B-L

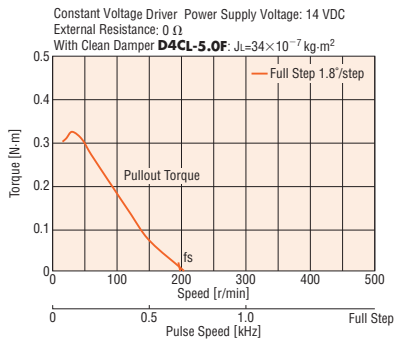

PKP245U08A-L/PKP245U08B-L

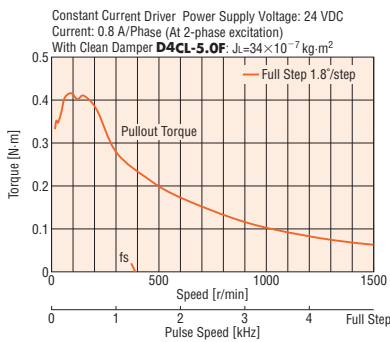

PKP245U12A-L/PKP245U12B-L

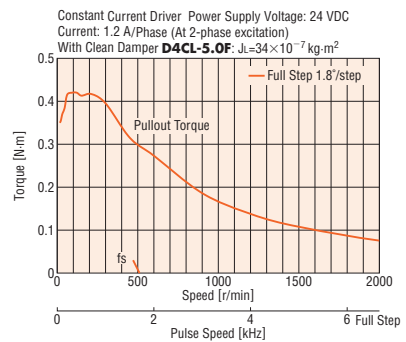

42 mm

56.4 mm

60 mm

PKP246U12A-L/PKP246U12B-L

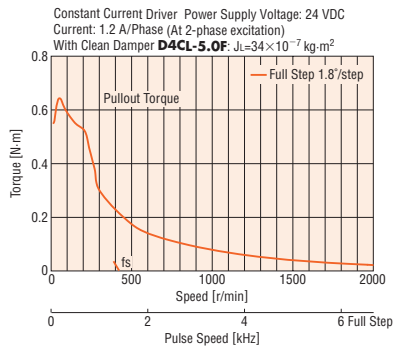

Note

Depending on the driving conditions, a considerable amount of heat may be generated by the motor. Be sure to keep the motor case temperature at 100°C or less.

Dimensions (Unit = mm)

Product Name	Motor Product Name	L1	L2	Mass kg
PKP243U04A-L	PKP243U04A	33	—	0.25
PKP243U04B-L	PKP243U04B		48	
PKP243U06A-L	PKP243U06A		—	
PKP243U06B-L	PKP243U06B		48	
PKP243U09A-L	PKP243U09A	39	—	0.3
PKP243U09B-L	PKP243U09B		48	
PKP244U04A-L	PKP244U04A		—	
PKP244U04B-L	PKP244U04B		54	
PKP244U08A-L	PKP244U08A	47	—	0.39
PKP244U08B-L	PKP244U08B		54	
PKP244U12A-L	PKP244U12A		—	
PKP244U12B-L	PKP244U12B		54	
PKP245U05A-L	PKP245U05A	47	—	0.39
PKP245U05B-L	PKP245U05B		62	
PKP245U08A-L	PKP245U08A		—	
PKP245U08B-L	PKP245U08B		62	
PKP245U12A-L	PKP245U12A	59	—	0.5
PKP245U12B-L	PKP245U12B		62	
PKP246U12A-L	PKP246U12A		—	
PKP246U12B-L	PKP246U12B		74	

- Applicable Connector
Connector Housing: 51103-0600 (Molex)
Contact: 50351-8100 (Molex)
Crimp Tool: 57295-5000 (Molex)

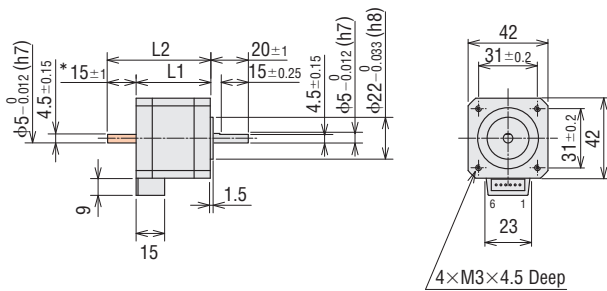

- * The length of the shaft flat on the double shaft model is 15±0.25.
- These dimensions are for double shaft models.
For single shaft models, ignore the shaft in the shaded areas.

- Included
Connection Cable
Product Name: **LC2U06B**

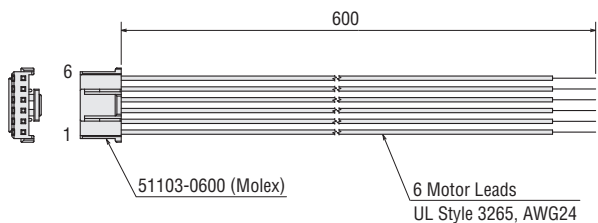

Accessories (Sold separately)

Connection cable and motor connector set are available as accessories.

- Connection cable → Page A-358
- Motor connector set → Page A-358

Standard Type Frame Size 56.4 mm (4 lead wires)

Specifications RoHS

Product Name	Connection Type	Maximum Holding Torque	Rotor Inertia	Rated Current	Voltage	Resistance per Phase	Inductance	Basic Step Angle	Wirings and Connections
Single Shaft Double Shaft		N·m	J: kg·m ²	A/Phase	VDC	Ω/Phase	mH/Phase		(See Page A-276)
PKP264D28A-L PKP264D28B-L	Bipolar	0.6	120×10^{-7}	2.8	2	0.73	1.8	1.8°	3
PKP266D28A-L PKP266D28B-L		1.4	290×10^{-7}		2.8	1	2.9		
PKP268D28A-L PKP268D28B-L		2.3	490×10^{-7}		3.4	1.23	4.4		

● A connection cable (0.6 m) is included.

Speed – Torque Characteristics

PKP264D28A-L/PKP264D28B-L

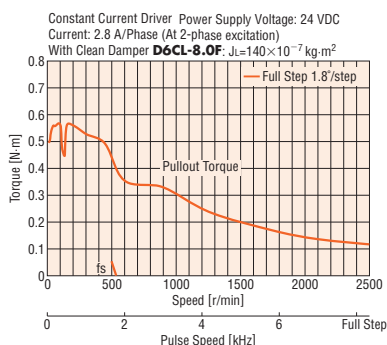

PKP266D28A-L/PKP266D28B-L

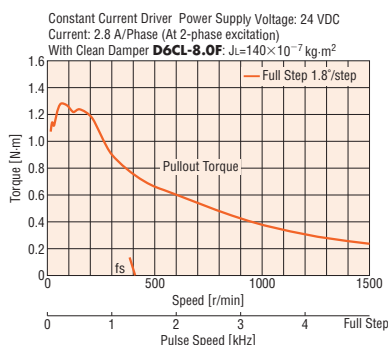

PKP268D28A-L/PKP268D28B-L

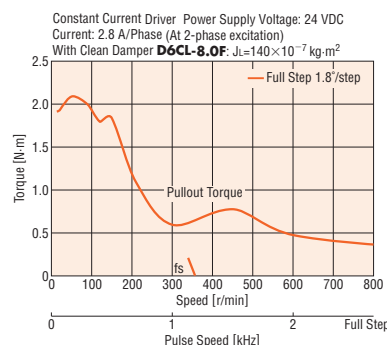

Note

● Depending on the driving conditions, a considerable amount of heat may be generated by the motor. Be sure to keep the motor case temperature at 100°C or less.

Dimensions (Unit = mm)

Product Name	Motor Product Name	L1	L2	Mass kg
PKP264D28A-L	PKP264D28A	39	—	0.46
PKP264D28B-L	PKP264D28B		62	
PKP266D28A-L	PKP266D28A	54	—	0.73
PKP266D28B-L	PKP266D28B		77	
PKP268D28A-L	PKP268D28A	76	—	1.1
PKP268D28B-L	PKP268D28B		99	

● Applicable Connector

Connector Housing: 51067-0600 (Molex)

Contact: 50217-9101 (Molex)

Crimp Tool: 57189-5000 (Molex)

57190-5000 (Molex)

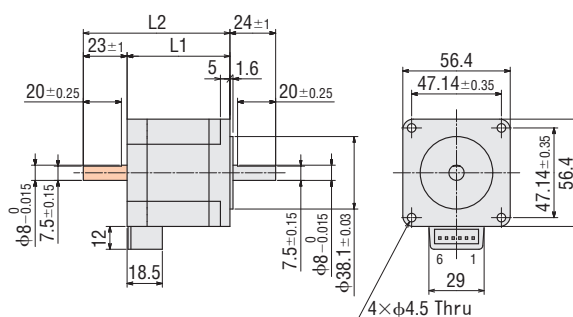

● These dimensions are for double shaft models.
For single shaft models, ignore the shaft in the shaded areas.

● Included
Connection Cable
Product Name: **LC2B06C**

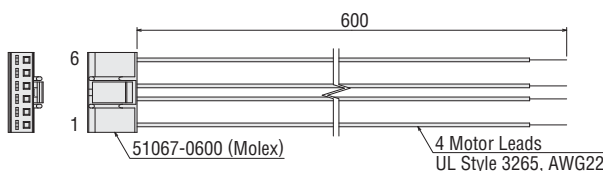

Accessories (Sold separately)

Connection cable and motor connector set are available as accessories.

● Connection cable → Page A-358

● Motor connector set → Page A-358

Standard Type Frame Size 56.4 mm (6 lead wires)

20 mm

28 mm

35 mm

42 mm

56.4 mm

60 mm

Specifications (RoHS)

Product Name	Connection Type	Maximum Holding Torque	Rotor Inertia	Rated Current	Voltage	Resistance per Phase	Inductance	Basic Step Angle	Wirings and Connections
Single Shaft Double Shaft		N·m	J: kg·m ²	A/Phase	VDC	Ω/Phase	mH/Phase		(See Page A-276)
PKP264U10A-L PKP264U10B-L	Unipolar	0.51	120×10 ⁻⁷	1	5.87	5.87	7.2	1.8°	1
PKP264U20A-L PKP264U20B-L				2	2.9	1.45	1.8		
PKP264U30A-L PKP264U30B-L				3	1.95	0.65	0.8		
PKP266U10A-L PKP266U10B-L		1.1	290×10 ⁻⁷	1	8.1	8.1	11.6		
PKP266U20A-L PKP266U20B-L				2	4	2	2.9		
PKP266U30A-L PKP266U30B-L				3	2.76	0.92	1.33		
PKP268U10A-L PKP268U10B-L		1.75	490×10 ⁻⁷	1	9.32	9.32	17.6		
PKP268U20A-L PKP268U20B-L				2	4.9	2.45	4.4		
PKP268U30A-L PKP268U30B-L				3	3.15	1.05	1.96		

● A connection cable (0.6 m) is included.

Speed – Torque Characteristics

PKP264U10A-L/PKP264U10B-L

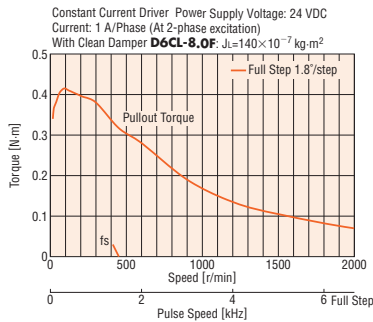

PKP264U20A-L/PKP264U20B-L

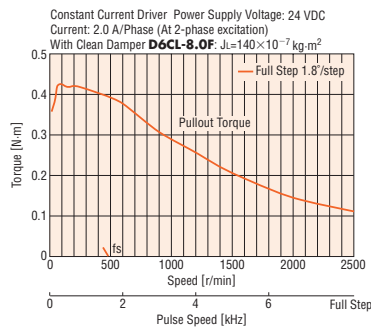

PKP264U30A-L/PKP264U30B-L

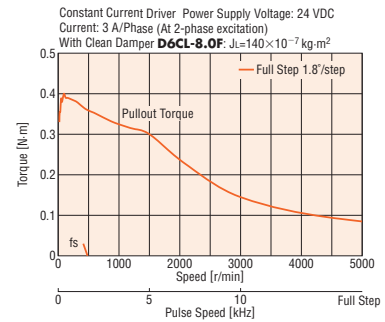

PKP266U10A-L/PKP266U10B-L

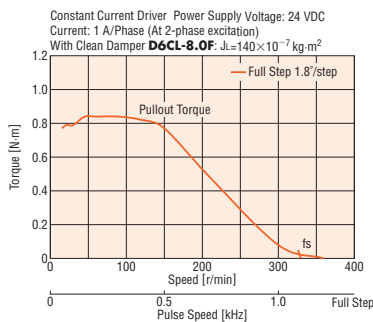

PKP266U20A-L/PKP266U20B-L

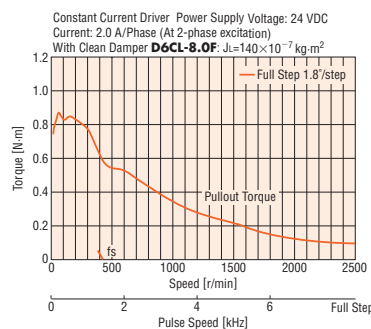

PKP266U30A-L/PKP266U30B-L

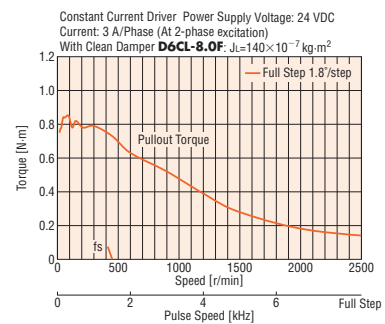

PKP268U10A-L/PKP268U10B-L

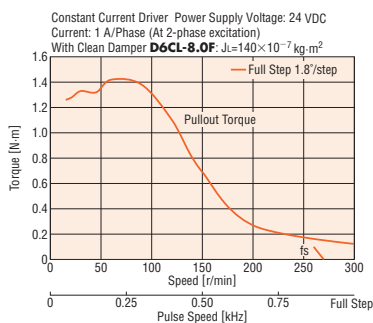

PKP268U20A-L/PKP268U20B-L

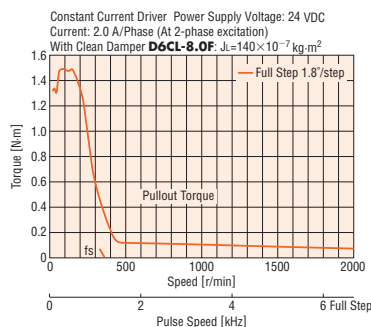

PKP268U30A-L/PKP268U30B-L

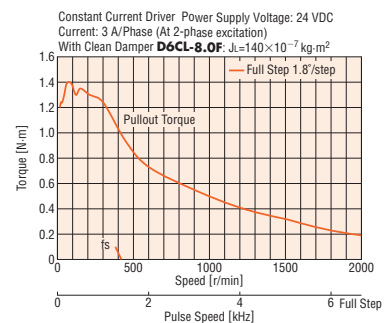

Note

● Depending on the driving conditions, a considerable amount of heat may be generated by the motor. Be sure to keep the motor case temperature at 100°C or less.

Dimensions (Unit = mm)

Product Name	Motor Product Name	L1	L2	Mass kg
PKP264U10A-L	PKP264U10A	39	-	0.46
PKP264U10B-L	PKP264U10B		62	
PKP264U20A-L	PKP264U20A		-	
PKP264U20B-L	PKP264U20B		62	
PKP264U30A-L	PKP264U30A		-	
PKP264U30B-L	PKP264U30B	54	-	0.73
PKP266U10A-L	PKP266U10A		-	
PKP266U10B-L	PKP266U10B		77	
PKP266U20A-L	PKP266U20A		-	
PKP266U20B-L	PKP266U20B		77	
PKP266U30A-L	PKP266U30A	76	-	1.1
PKP266U30B-L	PKP266U30B		77	
PKP268U10A-L	PKP268U10A		-	
PKP268U10B-L	PKP268U10B		99	
PKP268U20A-L	PKP268U20A		-	
PKP268U20B-L	PKP268U20B	99	-	
PKP268U30A-L	PKP268U30A		-	
PKP268U30B-L	PKP268U30B		99	

- Applicable Connector
Connector Housing: 51067-0600 (Molex)
Contact: 50217-9101 (Molex)
Crimp Tool: 57189-5000 (Molex)
57190-5000 (Molex)

Accessories (Sold separately)

Connection cable and motor connector set are available as accessories.

- Connection cable → Page A-358
- Motor connector set → Page A-358

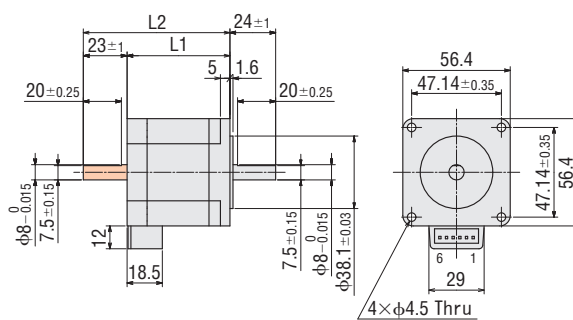

- These dimensions are for double shaft models.
For single shaft models, ignore the shaft in the shaded areas.

- Included
Connection Cable
Product Name: **LC2U06C**

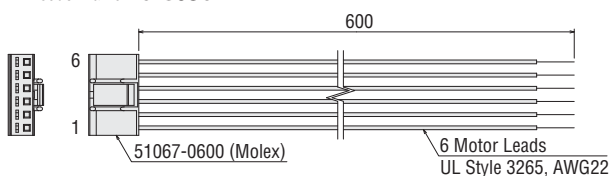

Introduction

0.36°/Geared
AR
AC Input Motor & Driver

0.72°/Geared
RK

0.36°/Geared
AR

0.36°/0.72°/
Geared
CRK
DC Input Motor & Driver

1.8°/Geared
RBK

0.9°/1.8°/Geared
CMK

0.72°
PK
Motor Only

1.8°/Geared
High-Torque
PKP

0.9°/1.8°/Geared
PK

Controllers
SG80301Y

Accessories

SH Geared Type Frame Size 28 mm (4 lead wires)

Specifications RoHS

Motor Specifications

Product Name	Connection Type	Rotor Inertia	Rated Current	Voltage	Resistance per Phase	Inductance	Wirings and Connections
Single Shaft Double Shaft		J: kg·m ²	A/Phase	VDC	Ω/Phase	mH/Phase	(See Page A-276)
PKP223D15A-SG□-L PKP223D15B-SG□-L	Bipolar	9×10 ⁻⁷	1.5	1.8	1.2	0.74	3

- A number indicating the gear ratio is entered where the box □ is located within the product name.
- A connection cable (0.6 m) is included.

Note

- The rotation direction of the motor and that of the gear output shaft are the same for the gear ratios 7.2 and 36. It is the opposite for 9, 10 and 18 gear ratio.

Gearmotor Specifications

Product Name	Maximum Holding Torque	Basic Step Angle	Gear Ratio	Permissible Torque	Backlash	Permissible Speed Range
Single Shaft Double Shaft	N·m			N·m	arc minute (degrees)	r/min
PKP223D15A-SG7.2-L PKP223D15B-SG7.2-L	0.3	0.25°	7.2	0.3	90 (1.5)	0~416
PKP223D15A-SG9-L PKP223D15B-SG9-L		0.2°	9			0~333
PKP223D15A-SG10-L PKP223D15B-SG10-L	0.4	0.18°	10	0.4		0~300
PKP223D15A-SG18-L PKP223D15B-SG18-L		0.1°	18			0~166
PKP223D15A-SG36-L PKP223D15B-SG36-L		0.05°	36			0~83

Speed – Torque Characteristics

PKP223D15A-SG7.2-L PKP223D15B-SG7.2-L

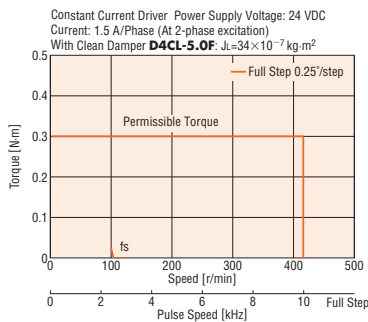

PKP223D15A-SG9-L PKP223D15B-SG9-L

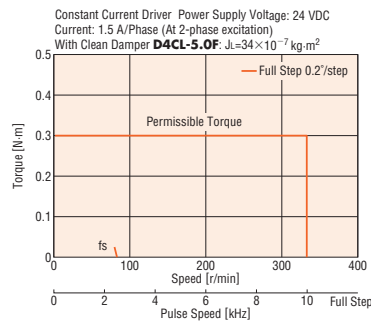

PKP223D15A-SG10-L PKP223D15B-SG10-L

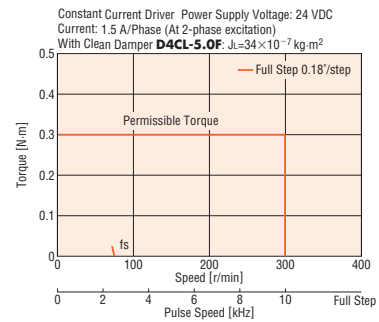

PKP223D15A-SG18-L PKP223D15B-SG18-L

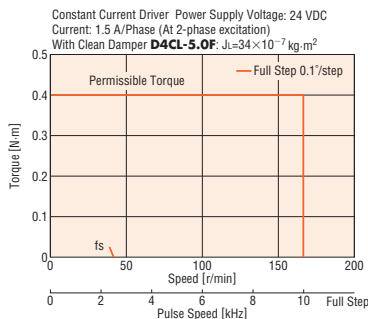

PKP223D15A-SG36-L PKP223D15B-SG36-L

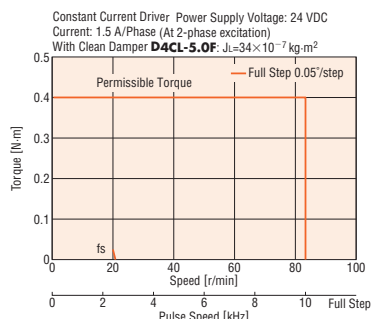

Note

- Depending on the driving conditions, a considerable amount of heat may be generated by the motor. Be sure to keep the motor case temperature at 100°C or less.

Dimensions

Refer to page A-274.

Accessories (Sold separately)

Connection cable and motor connector set are available as accessories.

- Connection cable → Page A-358
- Motor connector set → Page A-358

SH Geared Type Frame Size 28 mm (6 lead wires)

Specifications RoHS

Motor Specifications

Product Name	Connection Type	Rotor Inertia	Rated Current	Voltage	Resistance per Phase	Inductance	Wirings and Connections
Single Shaft Double Shaft		J: kg·m ²	A/Phase	VDC	Ω/Phase	mH/Phase	(See Page A-276)
PKP223U09A-SG -L PKP223U09B-SG -L	Unipolar	9×10 ⁻⁷	0.95	2.66	2.8	1	1

- A number indicating the gear ratio is entered where the box is located within the product name.
- A connection cable (0.6 m) is included.

Note

- The rotation direction of the motor and that of the gear output shaft are the same for the gear ratios 7.2 and 36. It is the opposite for 9, 10 and 18 gear ratio.

Gearmotor Specifications

Product Name	Maximum Holding Torque	Basic Step Angle	Gear Ratio	Permissible Torque	Backlash	Permissible Speed Range
Single Shaft Double Shaft	N·m			N·m	arc minute (degrees)	r/min
PKP223U09A-SG7.2-L PKP223U09B-SG7.2-L	0.3	0.25°	7.2	0.3	90 (1.5)	0~416
PKP223U09A-SG9-L PKP223U09B-SG9-L		0.2°	9			0~333
PKP223U09A-SG10-L PKP223U09B-SG10-L		0.18°	10			0~300
PKP223U09A-SG18-L PKP223U09B-SG18-L	0.4	0.1°	18	0.4		0~166
PKP223U09A-SG36-L PKP223U09B-SG36-L		0.05°	36			0~83

Speed – Torque Characteristics

PKP223U09A-SG7.2-L PKP223U09B-SG7.2-L

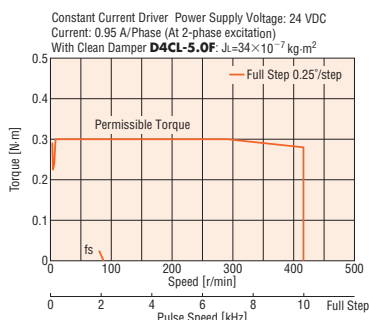

PKP223U09A-SG9-L PKP223U09B-SG9-L

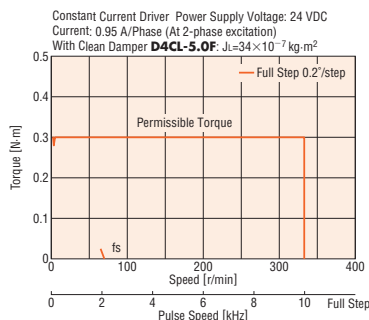

PKP223U09A-SG10-L PKP223U09B-SG10-L

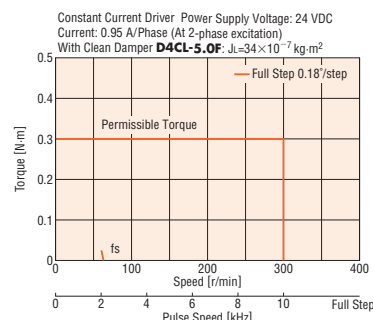

PKP223U09A-SG18-L PKP223U09B-SG18-L

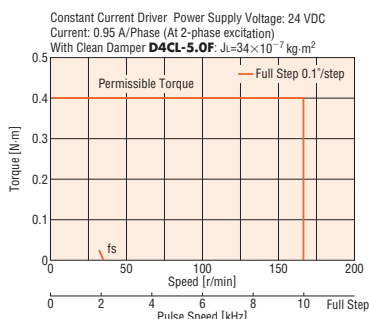

PKP223U09A-SG36-L PKP223U09B-SG36-L

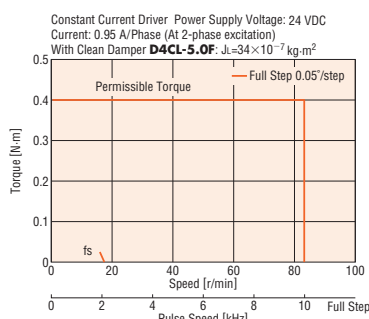

Note

- Depending on the driving conditions, a considerable amount of heat may be generated by the motor. Be sure to keep the motor case temperature at 100°C or less.

Dimensions

Refer to page A-274.

Accessories (Sold separately)

Connection cable and motor connector set are available as accessories.

- Connection cable → Page A-358
- Motor connector set → Page A-358

SH Geared Type Frame Size 42 mm (4 lead wires)

Specifications RoHS

Motor Specifications

Product Name	Connection Type	Rotor Inertia	Rated Current	Voltage	Resistance per Phase	Inductance	Wirings and Connections
Single Shaft Double Shaft		J: kg·m ²	A/Phase	VDC	Ω/Phase	mH/Phase	(See Page A-276)
PKP243D15A-SG -L PKP243D15B-SG -L	Bipolar	36×10 ⁻⁷	1.5	0.87	0.58	1.1	3

- A number indicating the gear ratio is entered where the box is located within the product name.
- A connection cable (0.6 m) is included.

Note

- The rotation direction of the motor and that of the gear output shaft are the same for the gear ratios 3.6, 7.2, 9 and 10. It is the opposite for 18 and 36 gear ratio.

Gearmotor Specifications

Product Name	Maximum Holding Torque	Basic Step Angle	Gear Ratio	Permissible Torque	Backlash	Permissible Speed Range
Single Shaft Double Shaft	N·m			N·m	arc minute (degrees)	r/min
PKP243D15A-SG3.6-L PKP243D15B-SG3.6-L	0.2	0.5°	3.6	0.2	90 (1.5°)	0~833
PKP243D15A-SG7.2-L PKP243D15B-SG7.2-L	0.4	0.25°	7.2	0.4	60 (1°)	0~416
PKP243D15A-SG9-L PKP243D15B-SG9-L	0.5	0.2°	9	0.5		0~333
PKP243D15A-SG10-L PKP243D15B-SG10-L	0.56	0.18°	10	0.56		0~300
PKP243D15A-SG18-L PKP243D15B-SG18-L	0.8	0.1°	18	0.8		0~166
PKP243D15A-SG36-L PKP243D15B-SG36-L		0.05°	36			0~83

Speed – Torque Characteristics

PKP243D15A-SG3.6-L
PKP243D15B-SG3.6-L

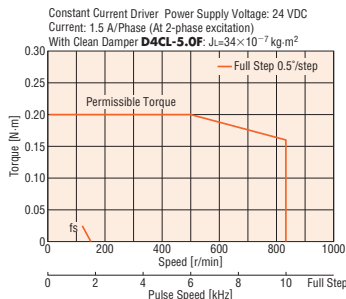

PKP243D15A-SG7.2-L
PKP243D15B-SG7.2-L

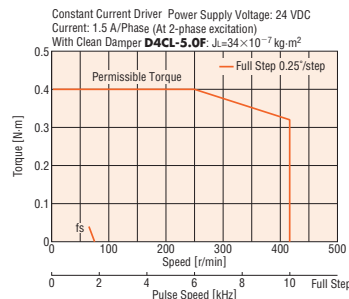

PKP243D15A-SG9-L
PKP243D15B-SG9-L

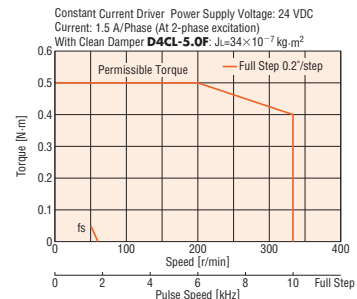

PKP243D15A-SG10-L
PKP243D15B-SG10-L

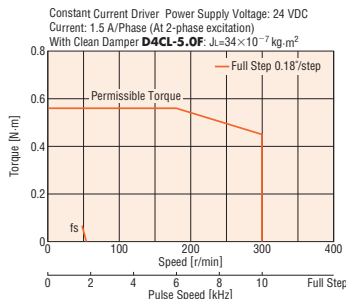

PKP243D15A-SG18-L
PKP243D15B-SG18-L

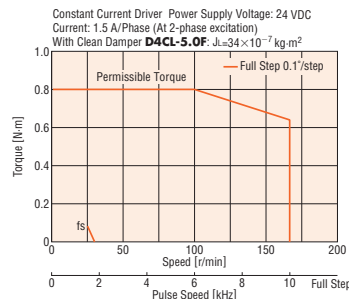

PKP243D15A-SG36-L
PKP243D15B-SG36-L

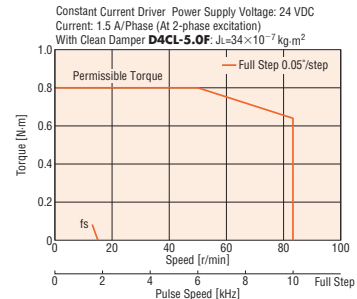

Note

- Depending on the driving conditions, a considerable amount of heat may be generated by the motor. Be sure to keep the motor case temperature at 100°C or less.

Dimensions

Refer to page A-274.

Accessories (Sold separately)

Connection cable and motor connector set are available as accessories.

- Connection cable → Page A-358
- Motor connector set → Page A-358

20 mm

28 mm

35 mm

42 mm

56.4 mm

60 mm

SH Geared Type Frame Size 42 mm (6 lead wires)

Specifications RoHS

Motor Specifications

Product Name	Connection Type	Rotor Inertia	Rated Current	Voltage	Resistance per Phase	Inductance	Wirings and Connections
Single Shaft Double Shaft		J: kg·m ²	A/Phase	VDC	Ω/Phase	mH/Phase	(See Page A-276)
PKP243U09A-SG□-L PKP243U09B-SG□-L	Unipolar	36×10 ⁻⁷	0.95	2.09	2.2	2.3	1

- A number indicating the gear ratio is entered where the box □ is located within the product name.
- A connection cable (0.6 m) is included.

Note

- The rotation direction of the motor and that of the gear output shaft are the same for the gear ratios 3.6, 7.2, 9 and 10. It is the opposite for 18 and 36 gear ratio.

Gearmotor Specifications

Product Name	Maximum Holding Torque	Basic Step Angle	Gear Ratio	Permissible Torque	Backlash	Permissible Speed Range
Single Shaft Double Shaft	N·m			N·m	arc minute (degrees)	r/min
PKP243U09A-SG3.6-L PKP243U09B-SG3.6-L	0.2	0.5°	3.6	0.2	90 (1.5)	0~833
PKP243U09A-SG7.2-L PKP243U09B-SG7.2-L	0.4	0.25°	7.2	0.4	60 (1°)	0~416
PKP243U09A-SG9-L PKP243U09B-SG9-L	0.5	0.2°	9	0.5		0~333
PKP243U09A-SG10-L PKP243U09B-SG10-L	0.56	0.18°	10	0.56		0~300
PKP243U09A-SG18-L PKP243U09B-SG18-L	0.8	0.1°	18	0.8		0~166
PKP243U09A-SG36-L PKP243U09B-SG36-L		0.05°	36		0~83	

Speed – Torque Characteristics

PKP243U09A-SG3.6-L PKP243U09B-SG3.6-L

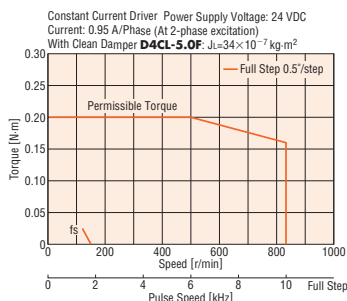

PKP243U09A-SG7.2-L PKP243U09B-SG7.2-L

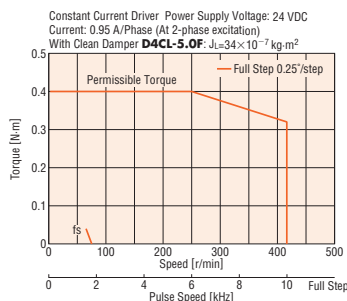

PKP243U09A-SG9-L PKP243U09B-SG9-L

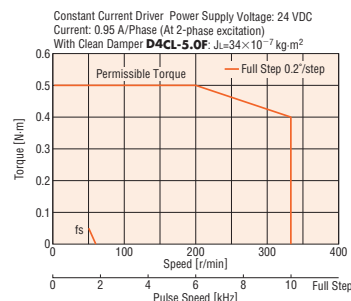

PKP243U09A-SG10-L PKP243U09B-SG10-L

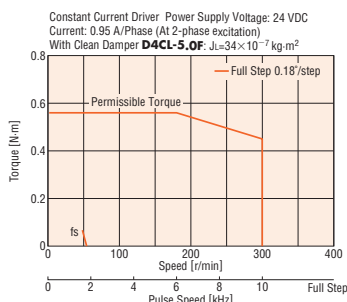

PKP243U09A-SG18-L PKP243U09B-SG18-L

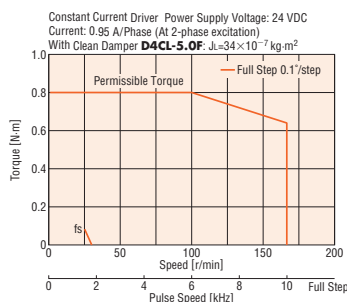

PKP243U09A-SG36-L PKP243U09B-SG36-L

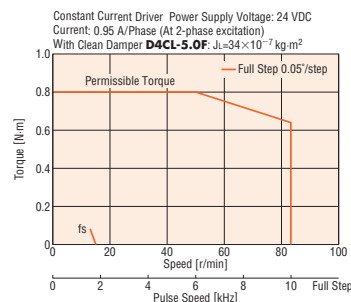

Note

- Depending on the driving conditions, a considerable amount of heat may be generated by the motor. Be sure to keep the motor case temperature at 100°C or less.

Dimensions

Refer to page A-274.

Accessories (Sold separately)

Connection cable and motor connector set are available as accessories.

- Connection cable → Page A-358
- Motor connector set → Page A-358

SH Geared Type Frame Size 60 mm (4 lead wires)

Specifications RoHS

● Motor Specifications

Product Name Single Shaft Double Shaft	Connection Type	Rotor Inertia J: kg·m ²	Rated Current A/Phase	Voltage VDC	Resistance per Phase Ω/Phase	Inductance mH/Phase	Wirings and Connections (See Page A-276)
PKP264D14A-SG□-L PKP264D14B-SG□-L	Bipolar	120×10 ⁻⁷	1.4	3.08	2.2	4.5	3
PKP264D28A-SG□-L PKP264D28B-SG□-L			2.8	0.92	0.33	0.8	

● A number indicating the gear ratio is entered where the box □ is located within the product name.

● A connection cable (0.6 m) is included.

Note

● The rotation direction of the motor and that of the gear output shaft are the same for the gear ratios 3.6, 7.2, 9 and 10. It is the opposite for 18 and 36 gear ratio.

● Gearmotor Specifications

Product Name Single Shaft Double Shaft	Maximum Holding Torque N·m	Basic Step Angle	Gear Ratio	Permissible Torque N·m	Backlash arc minute (degrees)	Permissible Speed Range r/min
PKP264D14A-SG3.6-L PKP264D14B-SG3.6-L	1	0.5°	3.6	1	70 (1.17°)	0~833
PKP264D28A-SG3.6-L PKP264D28B-SG3.6-L						
PKP264D14A-SG7.2-L PKP264D14B-SG7.2-L	2	0.25°	7.2	2	45 (0.75°)	0~416
PKP264D28A-SG7.2-L PKP264D28B-SG7.2-L						
PKP264D14A-SG9-L PKP264D14B-SG9-L	2.5	0.2°	9	2.5	45 (0.75°)	0~333
PKP264D28A-SG9-L PKP264D28B-SG9-L						
PKP264D14A-SG10-L PKP264D14B-SG10-L	2.7	0.18°	10	2.7	45 (0.75°)	0~300
PKP264D28A-SG10-L PKP264D28B-SG10-L						
PKP264D14A-SG18-L PKP264D14B-SG18-L	3	0.1°	18	3	45 (0.75°)	0~166
PKP264D28A-SG18-L PKP264D28B-SG18-L						
PKP264D14A-SG36-L PKP264D14B-SG36-L	4	0.05°	36	4	45 (0.75°)	0~83
PKP264D28A-SG36-L PKP264D28B-SG36-L						

20 mm

28 mm

35 mm

42 mm

56.4 mm

60 mm

Speed – Torque Characteristics

PKP264D14A-SG3.6-L PKP264D14B-SG3.6-L

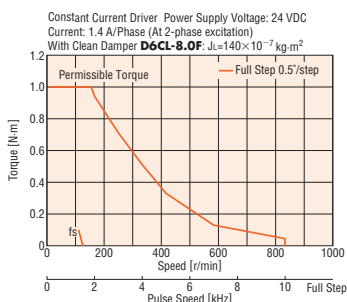

PKP264D14A-SG7.2-L PKP264D14B-SG7.2-L

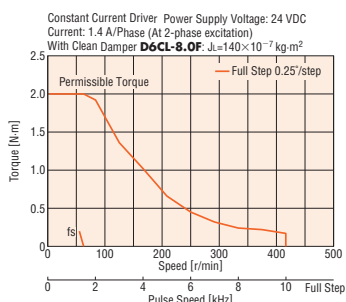

PKP264D14A-SG9-L PKP264D14B-SG9-L

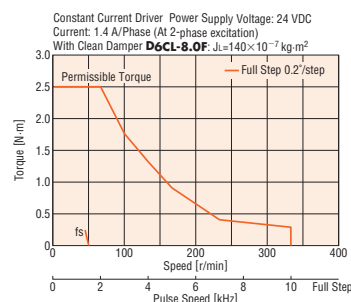

PKP264D14A-SG10-L PKP264D14B-SG10-L

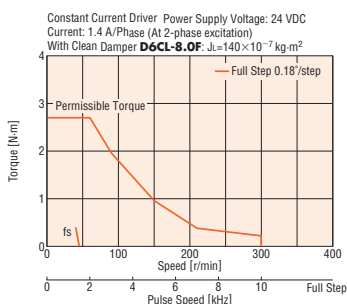

PKP264D14A-SG18-L PKP264D14B-SG18-L

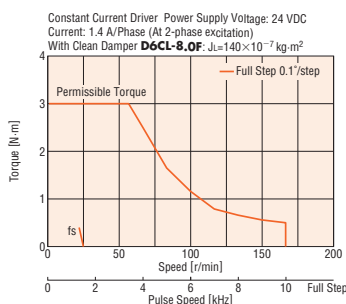

PKP264D14A-SG36-L PKP264D14B-SG36-L

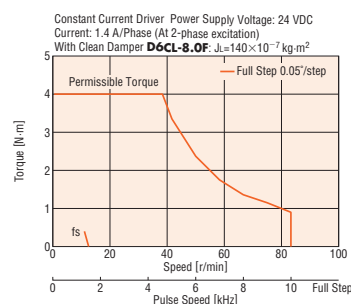

PKP264D28A-SG3.6-L PKP264D28B-SG3.6-L

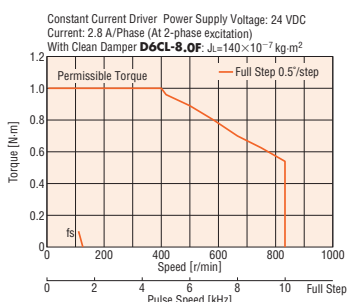

PKP264D28A-SG7.2-L PKP264D28B-SG7.2-L

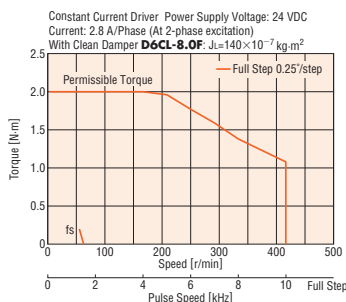

PKP264D28A-SG9-L PKP264D28B-SG9-L

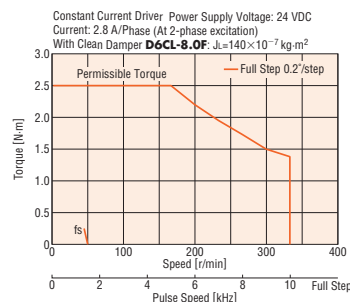

PKP264D28A-SG10-L PKP264D28B-SG10-L

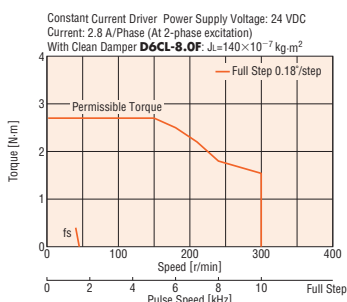

PKP264D28A-SG18-L PKP264D28B-SG18-L

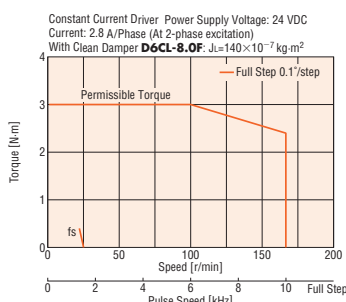

PKP264D28A-SG36-L PKP264D28B-SG36-L

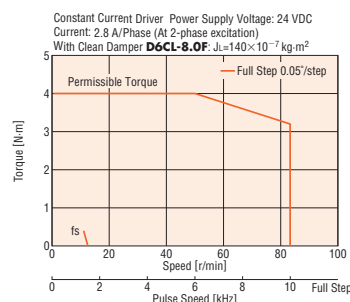

Note

- Depending on the driving conditions, a considerable amount of heat may be generated by the motor. Be sure to keep the motor case temperature at 100°C or less.

Dimensions

Refer to page A-275.

Accessories (Sold separately)

Connection cable and motor connector set are available as accessories.

- Connection cable → Page A-358
- Motor connector set → Page A-358

SH Geared Type Frame Size 60 mm (6 lead wires)

Specifications RoHS

● Motor Specifications

Product Name Single Shaft Double Shaft	Connection Type	Rotor Inertia J: kg·m ²	Rated Current A/Phase	Voltage VDC	Resistance per Phase Ω/Phase	Inductance mH/Phase	Wirings and Connections (See Page A-276)
PKP264U10A-SG -L PKP264U10B-SG -L	Unipolar	120×10 ⁻⁷	1	5.87	5.87	7.2	1
PKP264U20A-SG -L PKP264U20B-SG -L			2	2.9	1.45	1.8	

● A number indicating the gear ratio is entered where the box is located within the product name.

● A connection cable (0.6 m) is included.

Note

● The rotation direction of the motor and that of the gear output shaft are the same for the gear ratios 3.6, 7.2, 9 and 10. It is the opposite for 18 and 36 gear ratio.

● Gearmotor Specifications

Product Name Single Shaft Double Shaft	Maximum Holding Torque N·m	Basic Step Angle	Gear Ratio	Permissible Torque N·m	Backlash arc minute (degrees)	Permissible Speed Range r/min
PKP264U10A-SG3.6-L PKP264U10B-SG3.6-L	1	0.5°	3.6	1	70 (1.17°)	0~833
PKP264U20A-SG3.6-L PKP264U20B-SG3.6-L						
PKP264U10A-SG7.2-L PKP264U10B-SG7.2-L	2	0.25°	7.2	2	45 (0.75°)	0~416
PKP264U20A-SG7.2-L PKP264U20B-SG7.2-L						
PKP264U10A-SG9-L PKP264U10B-SG9-L	2.5	0.2°	9	2.5	45 (0.75°)	0~333
PKP264U20A-SG9-L PKP264U20B-SG9-L						
PKP264U10A-SG10-L PKP264U10B-SG10-L	2.7	0.18°	10	2.7	45 (0.75°)	0~300
PKP264U20A-SG10-L PKP264U20B-SG10-L						
PKP264U10A-SG18-L PKP264U10B-SG18-L	3	0.1°	18	3	45 (0.75°)	0~166
PKP264U20A-SG18-L PKP264U20B-SG18-L						
PKP264U10A-SG36-L PKP264U10B-SG36-L	4	0.05°	36	4	45 (0.75°)	0~83
PKP264U20A-SG36-L PKP264U20B-SG36-L						

20 mm

28 mm

35 mm

42 mm

56.4 mm

60 mm

Speed – Torque Characteristics

PKP264U10A-SG3.6-L
PKP264U10B-SG3.6-L

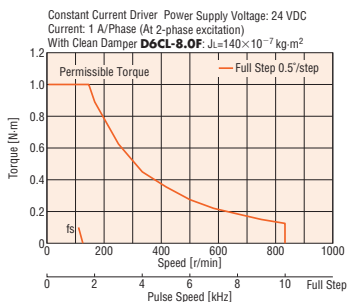

PKP264U10A-SG7.2-L
PKP264U10B-SG7.2-L

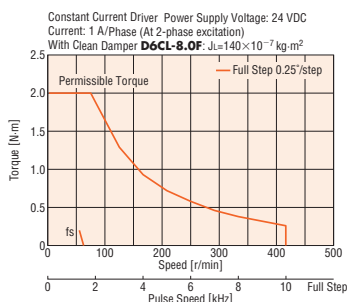

PKP264U10A-SG9-L
PKP264U10B-SG9-L

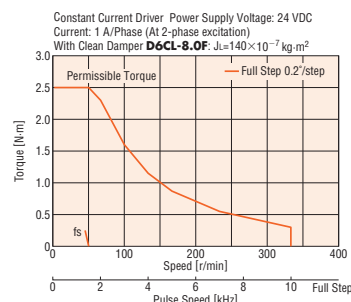

PKP264U10A-SG10-L
PKP264U10B-SG10-L

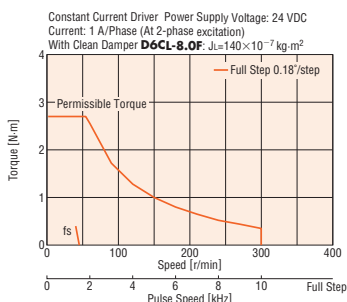

PKP264U10A-SG18-L
PKP264U10B-SG18-L

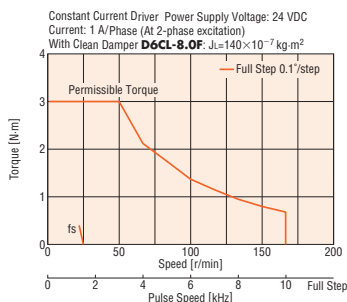

PKP264U10A-SG36-L
PKP264U10B-SG36-L

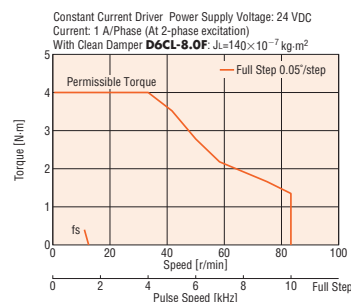

PKP264U20A-SG3.6-L
PKP264U20B-SG3.6-L

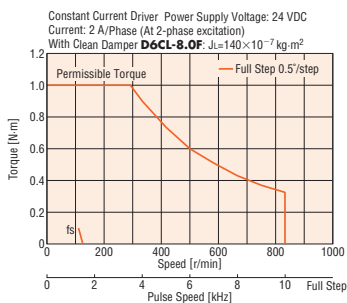

PKP264U20A-SG7.2-L
PKP264U20B-SG7.2-L

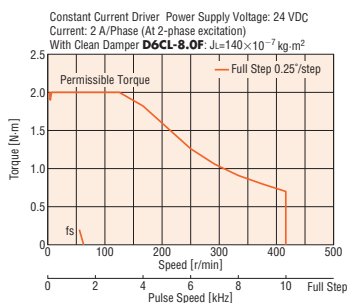

PKP264U20A-SG9-L
PKP264U20B-SG9-L

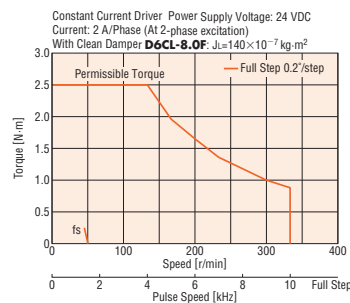

PKP264U20A-SG10-L
PKP264U20B-SG10-L

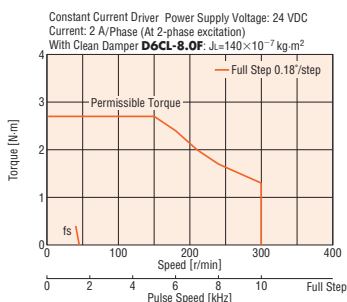

PKP264U20A-SG18-L
PKP264U20B-SG18-L

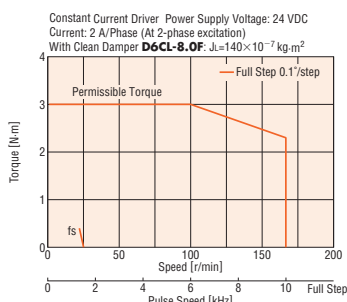

PKP264U20A-SG36-L
PKP264U20B-SG36-L

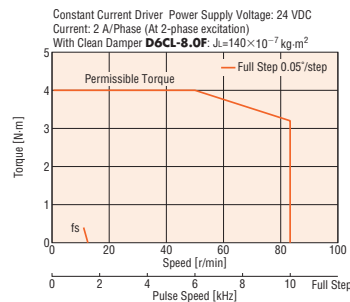

Note

- Depending on the driving conditions, a considerable amount of heat may be generated by the motor. Be sure to keep the motor case temperature at 100°C or less.

Dimensions

Refer to page A-275.

Accessories (Sold separately)

Connection cable and motor connector set are available as accessories.

- Connection cable → Page A-358
- Motor connector set → Page A-358

Introduction
AC Input Motor & Driver
0.36°/Geared AR C_{step}
0.72°/Geared RK
0.36°/Geared AR C_{step}
DC Input Motor & Driver
0.36°/0.72°/ Geared CRK
1.8°/Geared RAK
0.9°/1.8°/Geared CMK
0.72° PK
Motor Only
1.8°/Geared High-Torque PKP
0.9°/1.8°/Geared PK
Controllers SG80301Y
Accessories

Dimensions (Unit = mm)

Frame Size 28 mm

Connection Type	Product Name	Motor Product Name	Connection Cable Product Name	Gear Ratio	Mass kg
4 Lead Wires	PKP223D15A-SG□-L	PKP223D15A-SG□	LC2B06A	7.2, 9, 10, 18, 36	0.16
	PKP223D15B-SG□-L	PKP223D15B-SG□			
6 Lead Wires	PKP223U09A-SG□-L	PKP223U09A-SG□	LC2U06A		
	PKP223U09B-SG□-L	PKP223U09B-SG□			

- Applicable Connector
Connector Housing: 51065-0600 (Molex)
Contact: 50212-8100 (Molex)
Crimp Tool: 57176-5000 (Molex)

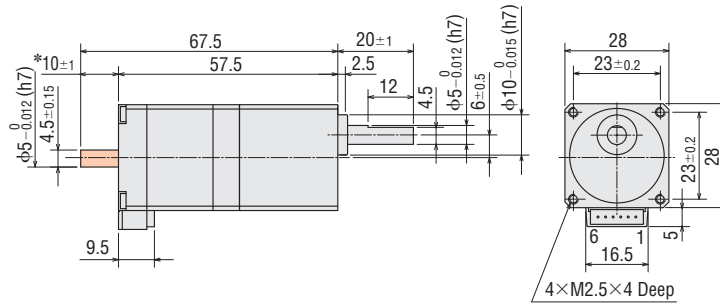

* The length of the shaft flat on the double shaft model is 10±0.25.

Connection Cable: **LC2B06A**

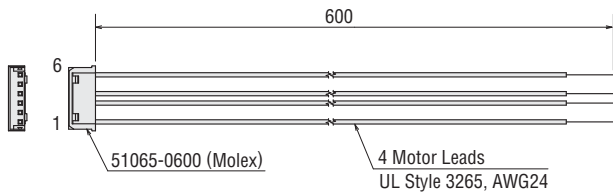

Connection Cable: **LC2U06A**

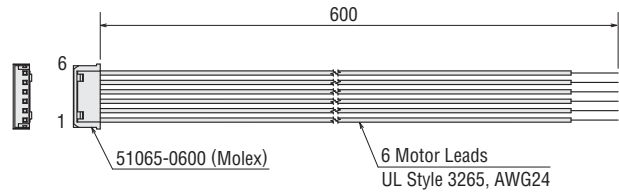

Frame Size 42 mm

Connection Type	Product Name	Motor Product Name	Connection Cable Product Name	Gear Ratio	Mass kg
4 Lead Wires	PKP243D15A-SG□-L	PKP243D15A-SG□	LC2B06B	3.6, 7.2, 9, 10, 18, 36	0.35
	PKP243D15B-SG□-L	PKP243D15B-SG□			
6 Lead Wires	PKP243U09A-SG□-L	PKP243U09A-SG□	LC2U06B		
	PKP243U09B-SG□-L	PKP243U09B-SG□			

- Applicable Connector
Connector Housing: 51103-0600 (Molex)
Contact: 50351-8100 (Molex)
Crimp Tool: 57295-5000 (Molex)

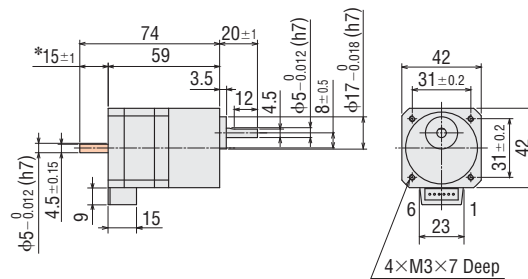

* The length of the shaft flat on the double shaft model is 15±0.25.

Connection Cable: **LC2B06B**

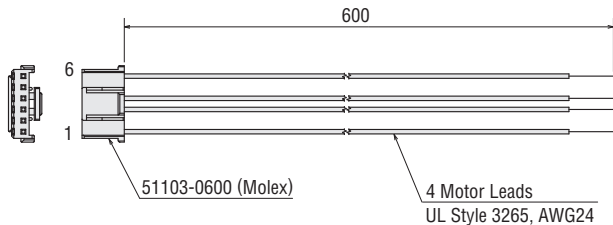

Connection Cable: **LC2U06B**

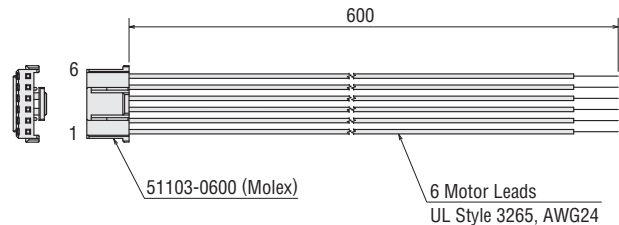

- A number indicating the gear ratio is entered where the box □ is located within the product name.
- These dimensions are for double shaft models. For single shaft models, ignore the shaft in the shaded areas.

Dimensions (Unit = mm)

Frame Size 60 mm

Connection Type	Product Name	Motor Product Name	Connection Cable Product Name	Gear Ratio	Mass kg
4 Lead Wires	PKP264D14A-SG □-L	PKP264D14A-SG□	LC2B06C	3.6, 7.2, 9, 10, 18, 36	0.76
	PKP264D14B-SG □-L	PKP264D14B-SG□			
	PKP264D28A-SG □-L	PKP264D28A-SG□			
	PKP264D28B-SG □-L	PKP264D28B-SG□			
6 Lead Wires	PKP264U10A-SG □-L	PKP264U10A-SG□	LC2U06C		
	PKP264U10B-SG □-L	PKP264U10B-SG□			
	PKP264U20A-SG □-L	PKP264U20A-SG□			
	PKP264U20B-SG □-L	PKP264U20B-SG□			

- Applicable Connector
- Connector Housing: 51067-0600 (Molex)
- Contact: 50217-9101 (Molex)
- Crimp Tool: 57189-5000 (Molex)
- 57190-5000 (Molex)

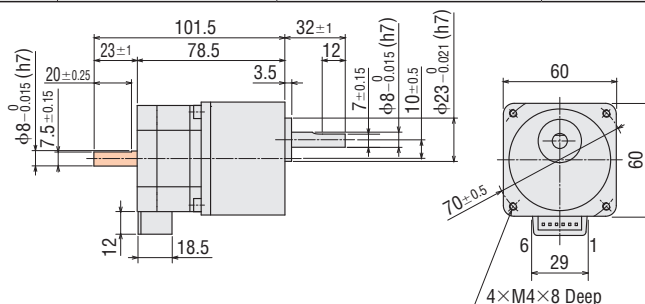

Connection Cable: **LC2B06C**

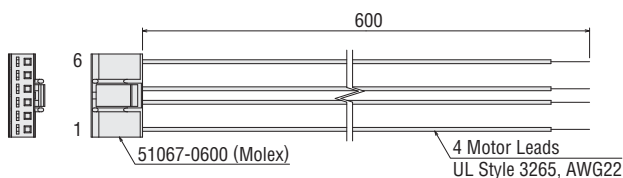

Connection Cable: **LC2U06C**

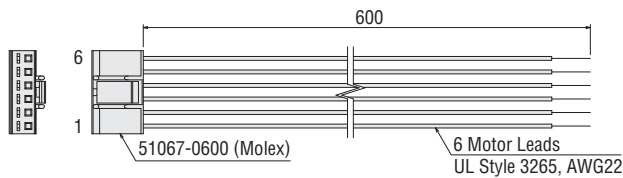

- A number indicating the gear ratio is entered where the box □ is located within the product name.
- These dimensions are for double shaft models. For single shaft models, ignore the shaft in the shaded areas.

20 mm

28 mm

35 mm

42 mm

56.4 mm

60 mm

General Specifications

Specifications		Motor						
Thermal Class		130 (B)						
Insulation Resistance		The measured value is 100 MΩ min. when a 500 VDC megger is applied between the windings and the case under normal ambient temperature and humidity.						
Dielectric Strength		No abnormality is judged even with application of 1.0 kVAC at 50 Hz or 60 Hz between the windings and the case for 1 minute under normal ambient temperature and humidity. (0.5 kV for models with a frame size of 42 mm or smaller.)						
Operating Environment (In operation)	Ambient Temperature	-10~+50°C (non-freezing)						
	Ambient Humidity	85% max. (non-condensing)						
	Atmosphere	Use in an area without corrosive gases or dust. The product should not be directly exposed to water, oil or other liquids.						
Temperature Rise		<ul style="list-style-type: none"> Unipolar and PKP21□D, PKP243D, PKP245D, SH Geared Type Temperature rise of windings is 80°C max. measured by the resistance change method (at rated voltage, at standstill, 2-phase excitation). PKP22□D, PKP23□D, PKP244D, PKP246D, PKP26□D Temperature rise of windings is 80°C max. measured by the resistance change method (at rated current, at standstill, 2-phase excitation). <p>The following motors are with aluminum heat radiation plates.</p> <table border="1"> <tr> <td>PKP22□D, PKP23□D</td> <td>: 115×115×5 mm</td> </tr> <tr> <td>PKP224D, PKP246D</td> <td>: 175×175×5 mm</td> </tr> <tr> <td>PKP26□D</td> <td>: 250×250×10 mm</td> </tr> </table>	PKP22□D, PKP23□D	: 115×115×5 mm	PKP224D, PKP246D	: 175×175×5 mm	PKP26□D	: 250×250×10 mm
PKP22□D, PKP23□D	: 115×115×5 mm							
PKP224D, PKP246D	: 175×175×5 mm							
PKP26□D	: 250×250×10 mm							
Stop Position Accuracy*1		±3 arc minutes (±0.05°) [PKP21□ : ±5 arc minutes (±0.083°)]						
Shaft Runout		0.05 T. I. R. (mm)*4						
Radial Play*2		0.025 mm max. (Load 5 N)						
Axial Play*3		0.075 mm max. (Load 10 N)						
Concentricity		0.075 T. I. R. (mm)*4						
Perpendicularity		0.075 T. I. R. (mm)*4						

*1 This value is for full step under no load. (The value changes with the size of the load).

*2 Radial Play: Displacement in shaft position in the radial direction when 5 N load is applied in the vertical direction to the tip of the motor's shaft.

*3 Axial Play: Displacement in shaft position in the axial direction when a 10 N load is applied to the motor's shaft in the axial direction.

*4 T. I. R. (Total Indicator Reading): The total dial gauge reading when the measurement section is rotated one revolution centered on the reference axis center.

Note

● Do not measure insulation resistance or perform the dielectric strength test while the motor and driver are connected.

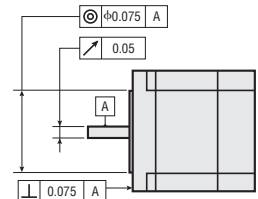

Windings and Connections

1 6 Leads Unipolar Connection

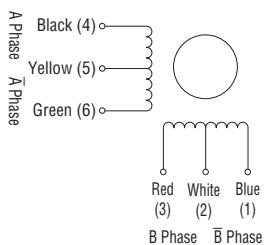

2 5 Leads Unipolar Connection

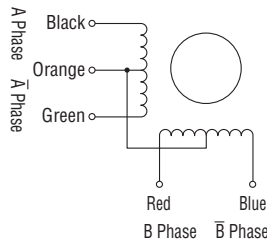

3 4 Leads Bipolar Connection

